

*corrimatec*

*PASSION OF CYCLING*

**ORDERBOOK**

**2023**

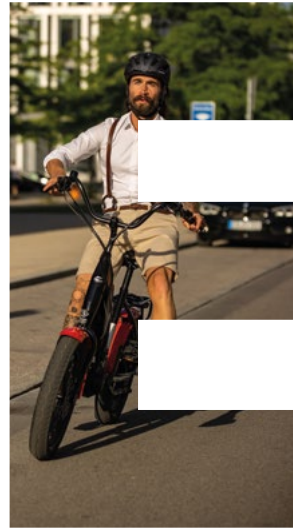
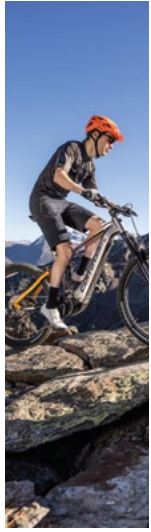



<b>VORWORT</b>	<b>3</b>	<b>PROLOGUE</b>
<b>UNSERE WERTE</b>	<b>5</b>	<b>OUR VALUES</b>
<b>HISTORIE</b>	<b>7</b>	<b>HISTORY</b>
<b>AUSZEICHNUNGEN</b>	<b>11</b>	<b>DISTINCTIONS</b>
<b>TEAM CORRATEC</b>	<b>13</b>	<b>TEAM CORRATEC</b>
<b>MTB RACINGTEAM</b>	<b>15</b>	<b>MTB RACINGTEAM</b>
<b>CORRATEC USA</b>	<b>17</b>	<b>CORRATEC USA</b>
<b>SIEGE</b>	<b>19</b>	<b>VICTORIES</b>
<b>DAS NEUE CCT EVO</b>	<b>23</b>	<b>THE ALL NEW CCT EVO</b>
<b>SHADOW EDGE 3.0</b>	<b>29</b>	<b>SHADOW EDGE 3.0</b>
<b>PARTNER</b>	<b>33</b>	<b>AMBASSADORS</b>
<b>WAS IST DEINE MISSION?</b>	<b>35</b>	<b>WHAT'S YOUR MISSION?</b>
<b>EINSATZBEREICHE</b>	<b>37</b>	<b>RANGE OF USE</b>
<b>TECHNOLOGIEN</b>	<b>39</b>	<b>TECHNOLOGIES</b>
<b>E-BIKE</b>	<b>41</b>	<b>E-BIKE</b>
<b>ROAD</b>	<b>117</b>	<b>ROAD</b>
<b>GRAVEL</b>	<b>135</b>	<b>GRAVEL</b>
<b>MOUNTAINBIKE</b>	<b>149</b>	<b>MOUNTAINBIKE</b>
<b>CITY &amp; TREKKING</b>	<b>175</b>	<b>CITY &amp; TREKKING</b>
<b>KLEIDUNG</b>	<b>187</b>	<b>CLOTHING</b>
<b>RAHMEN</b>	<b>197</b>	<b>FRAMES</b>





## **Konrad Irlbacher**

Gründer und Firmenchef  
Owner and CEO

## **Cielo Irlbacher**

Firmenchefin  
CEO

**W**ir leben in einer Welt der Veränderungen, die wir uns tagtäglich anpassen müssen. Der Wandel der Zeit treibt unser Denken und unser Handeln stetig an und stellt uns immer wieder vor neue Herausforderungen. Die Marke corratec steht seit über 30 Jahren für Innovation, Qualität und modernes Design das sich in unseren Produkten widerspiegelt. Wir sind sehr stolz, Ihnen als unsere wichtigsten Partner, dieses Jahr eine Bike Range der Superlative mit zahlreichen Innovationen und einer Weltneuheit in der urbanen Mobilität zu präsentieren. In jedem einzelnen Produkt steckt 100% Leidenschaft, Perfektion und modernste Technologie – made in Germany, hier in Raubling am Fuße der Alpen. Gemeinsam werden wir Ihre Kunden begeistern.

**W**e live in a world full of changes that we have to adapt to every day. This change of time drives our thinking to a new level of challenges and actions. The corratec brand stands for innovation, quality and modern design for more than 30 years, which is reflected in our products. We are very proud to present you as our most important partner, this year a superlative bike range with numerous innovations and a new world innovation in the urban mobility. There is 100% passion, perfection and the latest technology in every single product - Made in Germany, here in Raubling at the foot of the Alps. Together we will inspire your customers.

# **BIKES DEVELOPED IN GERMANY, BAVARIA.**

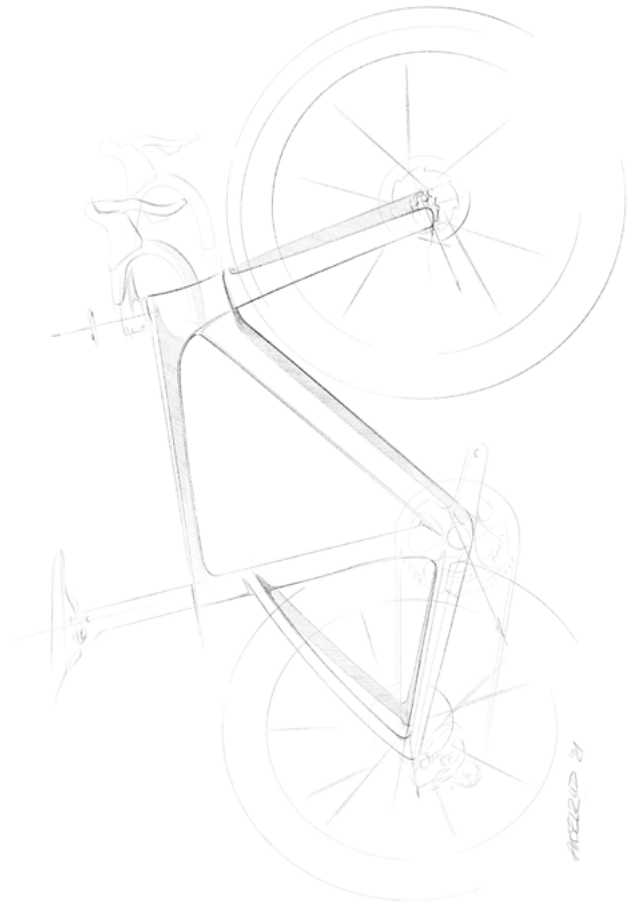

## **ENTWICKLUNG, DESIGN & PRODUKTION IN DEUTSCHLAND**

Seit Bestehen der Marke corratec - und dies schon in der zweiten Generation - sind wir dem Standort Raubling in Deutschland treu geblieben. Entwicklung, Konstruktion, Design und Montage sind und bleiben an unserem Firmensitz in Bayern am Fuße der Alpen. In diesem Paradies leben wir unsere Werte wie Tradition, Innovation, Hochwertigkeit, Sportlichkeit und Leidenschaft. Alle Produkte werden vom Eigentümer und CEO Konrad Irlbacher persönlich auf den Straßen, Wegen und Trails getestet und anschließend zur Produktion freigegeben. Somit erhalten Sie die Sicherheit, dass jedes corratec Bike ein erstklassiges und einzigartiges Produkt ist. Unsere Fahrradschmiede in Raubling produziert revolutionäre Innovationen wie am laufenden Band. Auch für die Saison 2023 werden wir den Markt revolutionieren. Mit unserer brandneuen Rennmaschine im Rennradbereich, dem CCT EVO, setzen wir den Benchmark.

## **GERMAN DEVELOPMENT, DESIGN AND ENGINEERING**

Since our foundation, we have remained loyal to our location Raubling, Germany, for already two generations. Engineering, assembly, research and development is located within our headquarter at the foot of the alps. In this paradise, we prosper to live by our values: Tradition, innovation, quality, sportiveness and passion. All products are personally tested by owner and CEO Konrad Irlbacher on the streets, paths and trails. Only after that testing the products will be released for production. Therefore we ensure the assurance that every corratec bike fulfills premium quality. Our bicycle forge in Raubling produces revolutionary innovations as if on a conveyor belt. We will also revolutionize the market for the 2023 season. With our brand new racing bike in the road bike segment, the CCT EVO, we are setting the benchmark.

# INNOVATION

## INNOVATION

WER WIR SIND, WAS WIR TUN

## UNSERE VISION

Unser Hauptziel, welches wir seit 1990 verfolgen, das Rad den Menschen näher zu bringen. Jede Maßnahme, die uns diesem Ziel näherbringt, wird von unseren Unternehmenswerten bestärkt. Corratec ist innovativ, sportlich, traditionell und hochwertig. Wir lieben den Sport. Unsere Kunden und Mitarbeiter stehen stets im Mittelpunkt deshalb wir legen besonderen Wert auf nachhaltiges Handeln. Gemeinsam möchten wir das Fahrrad neu erfinden und es zum Pendlerfahrzeug Nr. 1 im Nahverkehr machen.



## WHO WE ARE, WHAT WE DO

# OUR VISION

Our main goal, which we have been pursuing since 1990, to bring the bike closer to more people. Every action that brings us closer to this goal is reinforced by our corporate values. Corratec is innovative, sporty, traditionally and qualitative. We love the sport, our customers and employees are always in the focus therefore we attach particular importance to sustainable action. Together we want to reinvent the bicycle and make it the No. 1 commuter vehicle in local transport.



# SPORTLICHKEIT

## SPORTYNESS



# HOCHWERTIGKEIT QUALITY



# TRADITION TRADITION

*WAS WIR ANSTREBEN*

## UNSERE MISSION

Mit corrateg startet die zukunfft heute. Mobilität und Transport werden immer wichtiger und stellen wichtige Lebensgrundlagen dar. Deshalb tragen wir als weltweit agierendes Unternehmen dazu bei, die damit verbundenen, hohen Ansprüche zu erfüllen und arbeiten so als Partner Ihrer Wahl an neuen unverzichtbaren wegweisenden technologischen Lösungen. Hierzu orientieren wir uns an den gesellschaftlichen Trends, sowie dem rasanten Wachstum der Weltbevölkerung und der damit zusammenhängenden Urbanisierung. Aus diesen Entwicklungen leiten sich für uns drei Megatrends ab, jene bilden die Basis für unser strategisches Handeln sowie all unserer Geschäftsaktivitäten:

### *SICHERHEIT*

Zum Schutz von Leben und der Schonung von Umwelt.

### *UMWELT*

Ressourcenschonendes und emissionsfreies Fahren.

### *ERSCHWINGLICHE MOBILITÄT*

Individuelle Mobilität für alle ermöglichen.

*WHAT WE ASPIRE TO BE*

## OUR MISSION

With corrateg, the future starts today. Mobility and transport are becoming increasingly important and represent crucial foundations of life. That is why we, as a globally active company, contribute to meeting the associated high demands and thus work as your partner of choice on new, indispensable, groundbreaking technological solutions. To this end, we are guided by social trends and the rapid growth of the world's population and the associated urbanization. Three megatrends are derived from these developments and form the basis for our strategic actions and all our business activities:

### *SAFETY AND SECURITY*

To protect life and preserve the environment.

### *ENVIRONMENT*

Resource-saving and emission-free driving.

### *AFFORDABLE MOBILITY*

Enabling individual mobility for all.

# GESCHICHTE

## HISTORY

**1972**

### Gründung IKO Sportfachhandel

Konrad Irlbacher Senior gründet ein Fachgeschäft für Sportartikel in Rosenheim.

### Foundation

Konrad Irlbacher Senior establishes a shop for sporting goods in Rosenheim, Germany.

**1983**

**Erster Radsportkatalog**  
Räder der Marke Sannino werden in das Sortiment aufgenommen.

### First Bike Catalogue

The business starts selling Sannino bikes.

**1990**

### corrateg entsteht

Räder werden nun selbst produziert und tragen den Namen corrateg.

### corrateg is born

The business now focuses on manufacturing bikes under the brand name corrateg.

**1993**

### BOW Design

corrategs einzigartiger Bogen mit Wiedererkennungswert gewinnt den Red Dot Design Preis.

### BOW Design

corrategs unique BOW geometry is awarded with the Red Dot Design Prize.

**1994**

### Erster Weltcup Sieg

Jan Ostergaard siegt beim MTB Weltcup. Ein Meilenstein in der corrateg Geschichte.

### First MTB World cup title

Jan Ostergaard wins the MTB World Cup. The first milestone of the corrateg history.

**1994**

### Erster WM Titel

Bruno Risi holt den ersten WM-Titel für corrateg auf der Bahn.

### First World Champ title

Bruno Risi wins the first World Championship for corrateg on the race track.

**1995**

### Scheibenbremsen fürs Rennrad

corrateg entwickelt das erste Rennrad mit Scheibenbremsen. Eine bahnbrechende Innovation des Gründers Konrad Irlbacher.

### Disc Brake for Roadbikes

corrateg develops the first racing bike equipped with a disc brake.

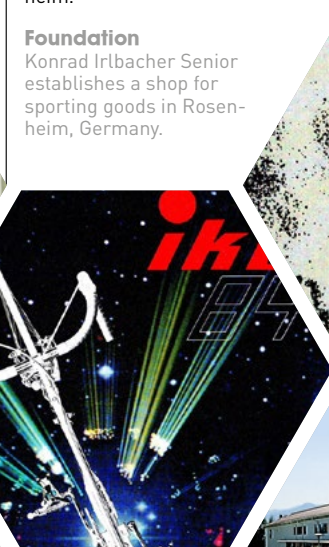



## 2000

**Air Tech Technologie**  
Der Dämpfer ist erstmals mittig befestigt, was zu direkter Kraftübertragung ohne Energieverlust führt.

**Air Tech Technology**  
The damper is fixed in the middle of it's case, that guarantees direct power control without loss of energy.



## 2006

**Revolution**  
Neue Maßstäbe in Funktionalität und Design: Super leichtes und schnelles Race Hardtail aus Carbon mit TCM Technologie.

**Revolution**  
A new standard in functionality and design: A super light and fast carbon race-hardtail with TCM technology.



## 2013

**Inside Link**  
Eine weitere Innovation entsteht. Allein durch die Kinematik bleibt der Hinterbau im Antritt straff ohne separaten Lockout.

**Inside Link**  
Another innovation from iko corratec. Due to the unique kinematic, the rear triangle remains tight during acceleration without remote lockout.



## 2014

**Deutscher Skiverband**  
corratec ist offizieller Lieferant der Deutschen Ski Nationalmannschaften.

**German Ski federation**  
corratec is official supplier of the German National Skiing Teams.



## 2010

**20 Jahre corratec**  
Das Leitmotiv COLOR YOUR WAY! steht bei corratec 2010 ganz besonders für einzigartige Fahrräder, lebendigen Fahrspaß und Fahrerlebnisse, die Alltag und Freizeit farbenfroh gestalten.

**20 Jahre corratec**  
The mission statement COLOR YOUR WAY! stands in the corratec 2010 series for unique bikes, active riding fun and experiences which color up your day and your leisure time.

## 2013

**Markteinführung E-Bikes**  
Markteinführung der ersten E-Bikes von corratec.

**25 years company anniversary**  
corratec looks back on a quarter century of company history.



## 2005

**Handgefertigt**  
corratec bietet seinen Kunden-Rahmen nach Maß an – handgefertigt unter der Leitung von Mauro Sannino.

**Handmade**  
corratec offers custom fitted frames – handmade by Mauro Sannino.

## 2015

**25 Jähriges Firmenjubiläum**  
corratec blickt auf ein viertel Jahrhundert Firmengeschichte zurück.

**25 years company anniversary**  
corratec looks back on a quarter century of company history.



## 2017

### Fusion Tube Edge

Der erste weltweit stabilste und sicherste corratec E-Bike Rahmen wird entwickelt.

### Fusion Tube Edge

The first worldwide most stable and safest corratec E-Bike frame.

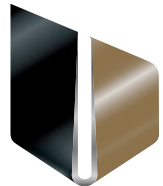
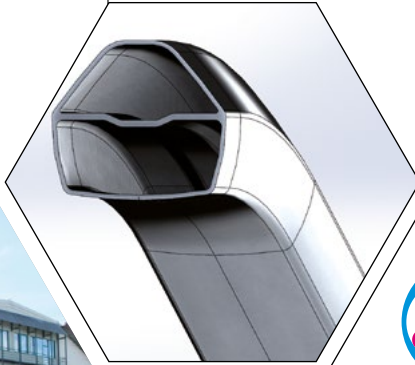

german  
brand  
award  
'18  
winner

## 2019

### Design Innovation Award

corratec wird für das innovative Life S Konzept ausgezeichnet.

### Design Innovation Award

corratec is awarded for the innovative Life S concept.



DESIGN &  
INNOVATION  
AWARD 2019

## 2018

### German Brand Award

corratec wird erstmalig mit dem German Brand Award als eine der beliebtesten Marken prämiert.

### German Brand Award

For the first time corratec is honored with the German Brand Award as one of the most popular brands.

## 2020

### German Brand Award

corratec erhält erneut die begehrte Auszeichnung als innovativste Marke in ihrem Segment.

### German Brand Award

corratec once again received the prestigious award as the most innovative brand in its segment.

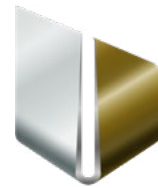

german  
brand  
award  
'20  
winner



GERMAN  
DESIGN  
AWARD  
SPECIAL  
2021

## 2021

### German Design Award

Das neu entwickelte Carbon Konzept E Power iLink 180 begeistert die Jury und präsentiert die Marke mit dem Design Award.

### German Design Award

The newly developed Carbon Concept E Power iLink 180 impressed the jury and presented corratec with the Design Award.

## 2021

### Shadow Edge 3.0

Die neue Rahmenkonstruktion von corratec erzeugt eine maximale Verwindungssteifigkeit des Unterrohrs.

### Shadow Edge 3.0

The new frame design from corratec creates maximum torsional rigidity of the down tube.



GERMAN  
INNOVATION  
AWARD '22  
WINNER

## 2022

### German Innovation Award

Die Mobilität der Zukunft, das corratec Life S Dual, gewinnt auf Anhieb den German Innovation Award.

### German Innovation Award

The mobility of the future, our corratec Life S Dual, wins the German Innovation Award.



## 2022

### ABC Award

Awards am laufenden Band für die Mobilität von Morgen. Das corratec Life S Dual gewinnt auch den ABC Award.

### ABC Award

The next award for the mobility of tomorrow. The corratec Life S Dual also wins the ABC Award.



# ***2022 BIKES MADE IN EUROPE, ROMANIA.***

## ***ERWEITERUNG UNSERER PRODUKTION IN TIMISOARA***

Ende 2021 konnten wir ein neues Betriebsgelände mit einer Größe von ca. 50.000m<sup>2</sup> inklusiv bebauter Fläche mit ca. 30.000m<sup>2</sup> an dem bestgelegenen Standort in Timisoara, Rumänien, erwerben. Damit reihen wir uns als Premium – Unternehmen neben bereits ansässigen Weltunternehmen wie Hilti, Bosch, Continental, Hela, Philips ein. Wir verfügen an diesem neuen Standort über qualifizierte Fachkräfte, um die Hochwertigkeit der corrateg Produkte auch in Zukunft zu sichern und weiter auszubauen. Dieser neue Standort ermöglicht uns die stark steigende Nachfrage der kommenden Jahre zu bewältigen. Verifiziert man die Parameter, Strecke, Zeit und Ressourcen, so befindet sich dieser Standort in einer geographisch optimalen Lage, im Herzen Europas. Alleine die Verkürzung der Lieferwege, ermöglicht uns eine Einsparung von ca. 700 Tonnen CO<sub>2</sub> pro Jahr. Verbaute Solarpanel für die Stromerzeugung werden zusätzlich ökologische Effekte erzielen, um ein corrateg Fahrrad oder eBike auch umweltschonend zu produzieren. Seit Januar 2022 werden in Timisoara corrateg Räder gefertigt.

## ***EXPANSION OF OUR PRODUCTION IN TIMISOARA***

At the end of 2021, we were able to acquire a new company site with a size of approx. 50,000m<sup>2</sup> including a built-up area of approx. 30,000m<sup>2</sup> at the best-located site in Timisoara in Romania. With this acquisition, we join the ranks of premium companies such as Hilti, Bosch, Continental, Hela, Philips and many others. At this new location, we have highly qualified specialists at our disposal to ensure and further expand the high quality of corrateg products in the future. This new location allows us to cope with the strong increase in demand in the coming years. Verifying the parameters, distance, time and resources, this location is in a geographically optimal position, centrally located in Europe. The shortening of the delivery routes alone enables us to save approximately 700 tons of CO<sub>2</sub>. Built-in solar panels for power generation will achieve additional ecological effects to produce a corrateg bike or eBike also environmentally friendly. Since January 2022, corrateg bikes are manufactured in Timisoara.



**DISTINCTIONS**

**SEIT JAHREN VORNE DABEI**

**AT THE FOREFRONT FOR YEARS**

**EINE ERFOLGSGESCHICHTE DIE ANHÄLT**  
**A SUCCESS STORY THAT LASTS**



**FOCUS  
E-BIKE**

**TOP**

**E-BIKE  
MARKEN**

**2021/22**

**BEKANNTESTE  
MARKE**

FOCUS E-BIKE  
Magazin 02/2021



**GERMAN  
DESIGN  
AWARD  
SPECIAL  
2021**



**SPONSORING  
WIR MACHEN SIEGER SEIT 1990  
WE MAKE CHAMPIONS SINCE 1990**

## TEAM CORRATEC



corratec engagiert sich seit vielen Jahren im professionellen Rennradsport und setzt sein Credo „Passion of cycling“ mit großem Erfolg um. Voller Stolz präsentiert corratec das mit vielen jungen Talenten bestückte Profiteam auf unseren neuen Rennmaschinen CCT EVO SLR Disc Team Edition. Für das Team corratec wurde ein exklusives Design unseres Highlight Rennrads entworfen, dass sich auch in den optisch sehr gelungenen Teamtrikots widerspiegelt. Das neu formierte Team ist im internationalen Rennzirkus unterwegs sein und hat bereits mit ersten Siegen für großes Aufsehen gesorgt!



corratec has been committed to professional road cycling for many years and has implemented its credo "Passion of cycling" with great success. corratec proudly presents the professional team, which is equipped with many young talents, on our new CCT EVO SLR Disc Team Edition racing machine. An exclusive design of our highlight racing bike was created for the corratec team, which is also reflected in the new very attractive team jerseys. The newly formed team will be on the international racing scene and has already gained it's first victories!







## CCT EVO TEAM EDITION

Der supersteife Rahmen des CCT EVO ist die perfekte Symbiose aus Leichtbau und Steifigkeit. Damit ist das CCT EVO das perfekte Rennbike für den Berg und schnelle Sprints. Die neue Teamlackierung erscheint im edlen Bordeaux Rot.

The stiff frame of the CCT EVO is the perfect symbiosis of lightweight construction and rigidity. This makes the CCT EVO the perfect racing bike for mountains and fast sprints. The new team design appears in elegant Bordeaux red.

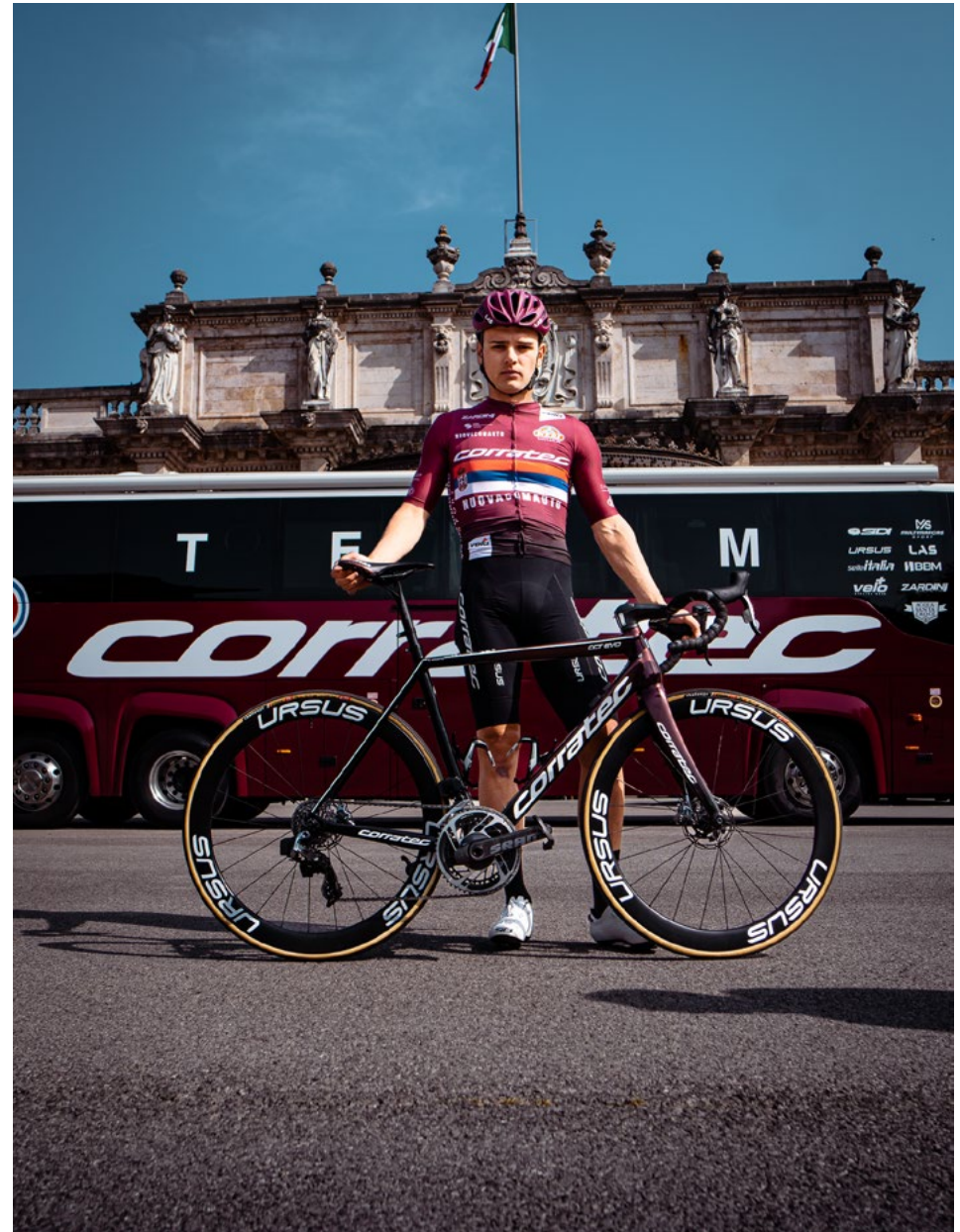



**SPONSORING  
WIR MACHEN SIEGER SEIT 1990  
WE MAKE CHAMPIONS SINCE 1990**

## MTB RACINGTEAM



Wir sind stolz darauf, das Mountainbike Racingteam auch in der kommenden Saison wieder zu unterstützen. Das vergangene Jahr 2021 war ein voller Erfolg für das UCI Team. Mit Simon Gegenheimer im Weltmeister Trikot freuen wir uns schon auf die bevorstehenden Rennen. Die Athleten des MTB Racingteams fahren auf internationaler Bühne um UCI Weltcupsiege. Das Team bestreitet die kommende Saison 2022 mit einem Kader aus sieben Top-Athleten. Davon begrüßen wir drei neue Profis im MTB Radsportzirkus. 2022 wird ein großartiges Jahr für das gesamte Team – und wir sind dabei!



We are proud to support the Mountainbike Racingteam again in the upcoming season. Last year 2021 was a full success for the UCI team. With Simon Gegenheimer in the world champion jersey we are already looking forward to the upcoming races. The athletes of the MTB Racingteam are competing for UCI World Cup victories on the international stage. The team will be racing in the 2022 season with a squad of seven top athletes. We welcome three of these new professionals to the MTB cycling circus. 2022 will be a great year for the whole team – and we are part of it!







## REVO BOW WM EDITION

Die Revo Bow Bikerange ist bekannt für ihr innovatives Design. Perlmutt Lackierung, stylisch gewölbtes Oberrohr und cleanes Kabelrouting mit innen verlegten Zügen. Im Renngeschehen auf Weltklasse Niveau sticht das Bike auffallend hervor und hebt sich von den anderen Rennmaschinen ab. Individualität ist hier die Prämisse!

The Revo Bow bikerange is known for its innovative design. A pearlescent finish, stylishly curved top tube and clean cable routing. In worldclass racing, the bike clearly attracts attention and differentiates itself from the other racing machines. Uniqueness is the premise!



# SPONSORING AMERICA WIR MACHEN SIEGER SEIT 2018 WE MAKE CHAMPIONS SINCE 2018

## *CORRATEC USA / AMERICA*

Seit August 2018 ist corrateg mit einer eigenen Niederlassung am amerikanischen Markt vertreten. Alle Vorgänge werden von unserem Headquarter in FT. Lauderdale, Florida gesteuert. Nicht nur in den USA, sondern auch in der dominikanischen Republik, Panama, Ecuador und Puerto Rico ist die Marke corrateg stark präsent und wächst stetig.

corrateg has had its own subsidiary on the American market since August 2018. All processes are carried out and controlled from our headquarters in FT. Lauderdale, Florida. The corrateg brand has a strong presence and is growing steadily not only in the USA, but also in the Dominican Republic, Panama, Ecuador, Puerto Rico and many more.



### **FERNANDO BOLONA**

corrateg Repräsentant in Amerika

Head of America Operations



## *CORRATEC AMERICA 2ND BIKE ELITE TEAM*

Die intensive Partnerschaft zwischen corrateg und unserem Partner „2nd Bike“ besteht seit mehreren Jahren und kann bereits großartige Erfolge vorweisen. Teamfahrer Ricky Morales wurde nun sogar als Fahrer für das UCI MTB Racingteam bestätigt.

The intensive partnership between corrateg and our partner “2nd Bike Elite” has existed for several years and can already boast some great successes. Team rider Ricky Morales has now even been nominated for the UCI MTB Racingteam.



## FLORIDA HBGS CORRATEC TEAM

Das in Hialeah im Bundesstaat Florida ansässige Rennteam setzt seit Jahren auf die Marke corrateg. Mit ihren Spitzenfahrern nimmt das Team in ganz USA an verschiedenen Rennen teil. Der Firmensitz unseres Partner-Unternehmens in Miami, Florida ist Anlaufpunkt für viele corrateg Teams und Logistikzentrum zugleich. Von dort werden alle Vorgänge koordiniert.

The racing team based in Hialeah, Florida, has relied on the corrateg brand for years. With their top riders, the team takes part in various races all over the USA. The headquarters of our partner company in Miami, Florida is the contact point for many corrateg teams and a logistic base as well. All processes are coordinated from there.



## TEAM PUERTO RICO

Seit 2021 führt das Team corrateg Puerto Rico die erfolgreiche Tradition und großartige corrateg Erfolgsgeschichte im Spirit von corrateg – passion of cycling – erfolgreich weiter.

Since 2021, the team corrateg Puerto Rico started to represent the corrateg tradition far away from corrateg´s home, of course keeping the same values.

## PANAMA RPC CORRATEC TEAM

Das aus Panama stammende RPC Racing Team besteht mittlerweile aus einer Vielzahl an Leistungsträgern – weiblich wie männlich. Herausragende Erfolge konnten bereits auf unseren corrateg Rennrädern eingefahren werden.

The RPC Racing Team from Panama consists of a large number of top performers – female and male. Outstanding successes have already been achieved on our corrateg road bikes.





# VICTORIES WIR SCHAFFEN ERINNERUNGEN WE CREATE MEMORIE THAT LAST

- 20 × bei großen int. Radmarathons  
at huge international cycling marathons  
Nove Colli | Felice Gimondi, Amade | Engadin | Dolomiten | Mondsee & more
- 20 × bei großen int. Bergrennen  
at huge international mountain races  
Kaunertaler | Kühtai | Kitzbüheler Horn | Stilfserjoch | Penserjoch & more
- 12 × Gewinner Grossglockner Herren und Damen  
Winner Grossglockner Men and Women
- 8 × Mastereuropameister - Zeitfahren & Straße  
Master European Champion - Timetrial & Road
- 7 × Sieg "Dolomitenman" Herren  
Victory "Dolomitenman" Men
- 5 × Gesamtsieg Glocknerkönig Strecke "Classic"  
Overall Victory Glocknerkönig Track "Classic"
- 4 × Gesamtsieg Öztaler Radmarathon  
Overall Victory Öztaler Radmarathon
- 3 × Etappensiege Giro d'Italia  
Stage victories Giro d'Italia
- 3 × Sieg overall Transalp MTB  
Victory GC Transalp MTB
- 2 × Deutscher Profimeister Straße  
German Champion Road

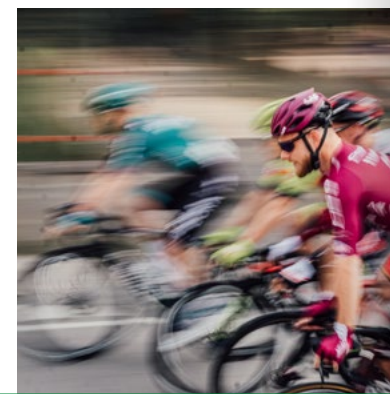
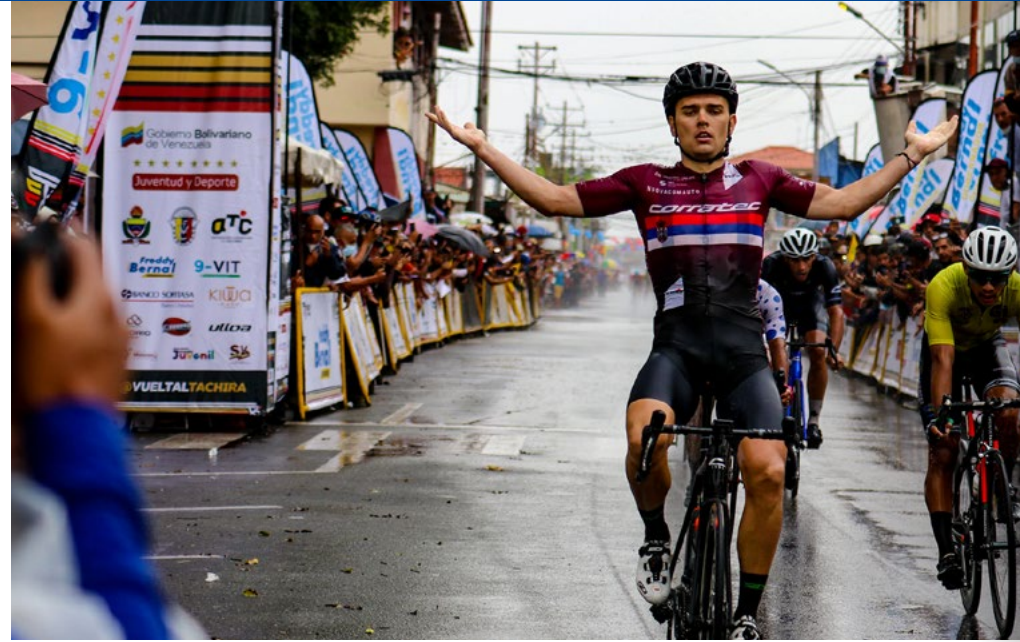



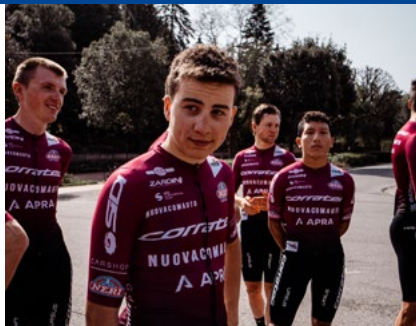

**corratec**

## WORLD TEAMS & ATHLETES

BESONDERE AUSGEWÄHLTE

LEISTUNGSTRÄGER

SELECTED SPECIAL RIDERS

Jan Erik Ostergaard | DK

Bruno Risi | CH

Kurt Betschart | CH

José Rujano | VE

Iván Parra | VE

Franz Stocher | AT

Dirk Müller | DE

Roland Stauder | IT

Michael Casagrande | IT

Michael Spögl | IT

Johannes Berndt | DE

Bernd Hornetz | DE

Wolfgang Hoffmann | DE

Daniel Debertin | DE

Frederic Glorieux | BE

Bob Michels | BE

Andreas Schmoll | DE

Isabell Vogel | DE

Ben Witt | DE

Stefan Oeffl | DE

Jan Wessely | DE

Michael Markolf | DE

Simon Gegenheimer | GER

Marion Fromberger | GER

Steffen Thum | GER

Remi Laffont | FRA

Gali Weinberg | ISR

Rob Vanden Haesevelde | BEL

Team Vini Zabú | ITA

Markus Emmerich | DE

Martin Reisner | DE

Tomas Mojares | PHIL

Bart Bury | BEL

Klaus Steinkeller | DE

Michael Kastinger | DE

Lisa Neumüller | DE

Andreas Ortner | DE

Felix Spensberger | DE

Jany Messmann | DE

Kuno Messmann | DE

Reinhilde Mager | DE

Karin Bordhin | DE

Roland Döring | DE

Jocelyn Verdenal | FRA

Matthijs Koedik | NED



**VICTORIES  
WIR SCHAFFEN ERINNERUNGEN  
WE CREATE MEMORIE THAT LAST**







Weltcup Gesamtsieger UCI MTB Eliminator  
Overall World cup UCI MTB Eliminator

Weltmeister UCI MTB Eliminator  
World champion UCI MTB Eliminator

Grünes Trikot Giro d'Italia  
Green Jersey Giro d'Italia

Gesamtweltcup Sieger MTB Marathon Damen und Herren  
World Cup Winner MTB Marathon Men and Women

Weltcup Gesamtsieg im Punktefahren  
World Cup overall Track Point Race

MTB UCI Worldcup Sieg Valkenswaard I Niederlande  
Victory MTB UCI Worldcup Valkenswaard I Netherlands

MTB UCI Worldcup Sieg Barcelona I Spanien  
Victory MTB UCI Worldcup Barcelona I Spain

Etappe UCI Pro Tour Coppi e Bartali I Italien  
Stage Victory UCI Pro Tour Coppi e Bartali I Italy

Grünes Trickot Giro d'Sicilia  
Green Jersey Giro d'Sicilia

Weltmeister im Punktefahren  
World Champion Track Point Race

Sechstagesport Sieger  
Six days Sport victories

Europameistertitel Team Relay Moskau  
European Championship Team Relay Moscow

Crocodil Trophy Australia  
Crocodil Trophy Australia

Bergwertung Deutschland Tour  
King of the mountain Tour of Germany

Etappe UCI Pro Tour Trofej Umag I Kroatien  
Stage Victory UCI Pro Tour Trofej Umag I Croatia



**DAS NEUE**  
THE ALL NEW

***CCT EVO***

**WIR SETZEN NEUE MASSSTÄBE**  
WE ARE SETTING NEW STANDARDS

Wie auch bei dem Vorgänger sind wir wieder den Weg des geringsten Widerstand gegangen. Schließlich soll man sich bei uns nicht zwischen Gewicht, Aerodynamik, Fahrqualität oder Geschwindigkeit entscheiden müssen. Und was sollen wir sagen: 800g Rahmengewicht ohne Abstriche bei der Aerodynamik, Steifigkeit oder Fahrqualität. In unserem Bestreben für jeden das perfekte Bike zu bieten, haben wir hier maximale Individualisierbarkeit umgesetzt mit einem zugleich unübertroffenen Perfektionismus. Kein Gramm zu viel, kein Feature unnütz - Ganz nach dem Motto "So viel wie nötig, so wenig wie möglich". Die Zeiten in denen wir einen Kompromiss zwischen Gewicht und Aerodynamik eingehen mussten sind nun vorbei mit den schnellsten corratec Rennrad aller Zeiten.

As with the predecessor, we took the path of least resistance here. Finally, you should not have to choose between weight, aerodynamics, ride quality or speed. And what can we say: 800g frame weight without sacrificing aerodynamics, stiffness or ride quality. In our quest to provide the perfect bike for everyone, we've implemented maximum customizability here with a minimalism that's unsurpassed at the same time. Not a gram too much, no feature useless - True to the motto "As much as necessary, as little as possible". The times in which we had to compromise between weight and aerodynamics are now over with the fastest corratec road bike ever.



# **CCT EVO**

## **FAST JUST GOT FASTER**

### **FEDERLEICHT**

### **FEATHERLIGHT**

Unglaublich aber wahr. Der neue Rahmen kommt auf ein sensationelles Gewicht von 800 Gramm und ist zugleich noch supersteif. Eine absolute Allzweckwaffe, Climber, Sprinter und Rolleur in einem Paket.

Unbelievable but true. The new frame has a sensationally light weight of 800 grams and is super stiff at the same time. An absolute all-purpose weapon, climber, sprinter and roller in one package.

### **SPORTLICH & AGGRESSIV**

### **SPORTY & AGGRESSIVE**

Das neue CCT EVO ist sportlicher und aggressiver unterwegs als sein Vorgänger. Dafür wurde der Faktor bzw. das Verhältnis zwischen Reach & Stack neu definiert. Der Reach ist länger und der Stack tiefer. Mit dieser sportlichen und gleichzeitig komfortablen Sitzposition die gewinnst du zusätzliche 8 Watt.

The new CCT EVO is sportier and more aggressive than its predecessor. To achieve this, the factor or the relationship between reach and stack has been redefined. The reach is longer and the stack lower. With this sporty seating position, which is also comfortable, you gain an additional 8 watts.







## **BOW SITZSTREBE**

### *BOW SEAT STAY*

Der legendäre corratec Bow darf auch beim neuen CCT EVO nicht fehlen. Die neue Sitzstrebe wurde in der traditionellen Rahmenform entwickelt und bietet technische Innovationen auf Weltklasse Niveau. Nur ein Stichwort: 8 Watt. Der Leistungsvorteil den Dir die Bow Sitzstrebe bietet. Gleichzeitig werden Micro Vibrationen abgedämpft ohne dabei an Steifigkeit zu verlieren.

The legendary corratec Bow is also a must for the new CCT EVO. The new seat stay was developed in the traditional frame shape and offers technical innovations on a world-class level. Just one keyword: 8 watts. The power advantage that the Bow seat stay offers you. At the same time, micro vibrations are damped without losing stiffness.

## **INTEGRATION IN PERFEKTION**

### *INTEGRATION IN PERFECTION*

Perfektion ist der neue Standard beim CCT EVO. Es wurde alles integriert was nur integriert werden kann. Sogar die Ausfallenden der Steckachsen sind komplett im Rahmen integriert und bilden einen formschönen sowie aerodynamischen Abschluss. Der entsprechende Sechskant Schlüssel zum Entfernen der Achse ist immer am Fahrrad um das Hinter- bzw. Vorderrad jederzeit entfernt zu können.

Perfection is the new standard for the CCT EVO. Everything that can be integrated has been integrated. Even the dropouts of the thru axles are completely integrated into the frame and form an attractive and aerodynamic finish. The corresponding hexagonal key for removing the axle is always on the bike and the rear or front wheel can be removed at any time.





## **RACE COCKPIT**

Rennfahren wie die Profis. Dank ergonomischer Lenkerdrops die speziell an die Taillierung der Daumen angepasst wurden, kannst du eine perfekte aerodynamische Position einnehmen und fühlst dich dabei noch pudelwohl. Eine Computer Mount ist integriert und fügt sich formschön in die Optik des Cockpits ein.

Race like the pros. Thanks to ergonomic handlebar drops that have been specially adapted to the waist of the thumbs, you can adopt a perfect aerodynamic position and still feel very comfortable. A computer mount is integrated and fits beautifully into the look of the cockpit.

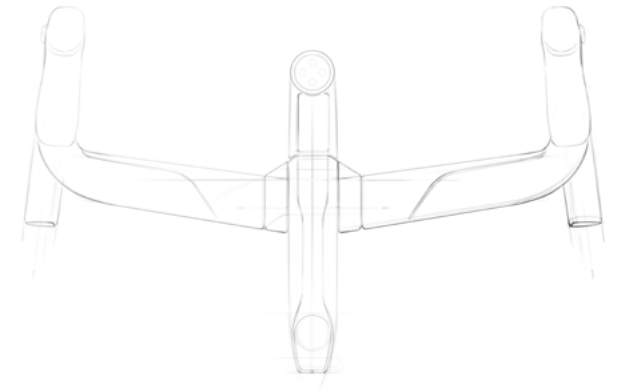

## **BUMERANG LINE**

Mit der Designsprache erinnert die neue Gabel an einen Bumerang, daher auch der Name "Bumerang Line". In Verbindung mit dem Oberrohr läuft das Design perfekt in die Gabelform über. Integration in Perfektion. Optisch ein Highlight kombiniert mit herausragenden Fahreigenschaften: Laufruhe, Stabilität & Agilität. Gleichzeitig können Reifen bis zu 32mm montiert werden.

With its design language, the new fork is reminiscent of a boomerang, hence the name "Boomerang Line". In conjunction with the top tube, the design flows perfectly into the fork shape. Integration in perfection. A visual highlight combined with outstanding handling characteristics: smooth running, stability & agility. At the same time, tyres up to 32mm can be mounted.





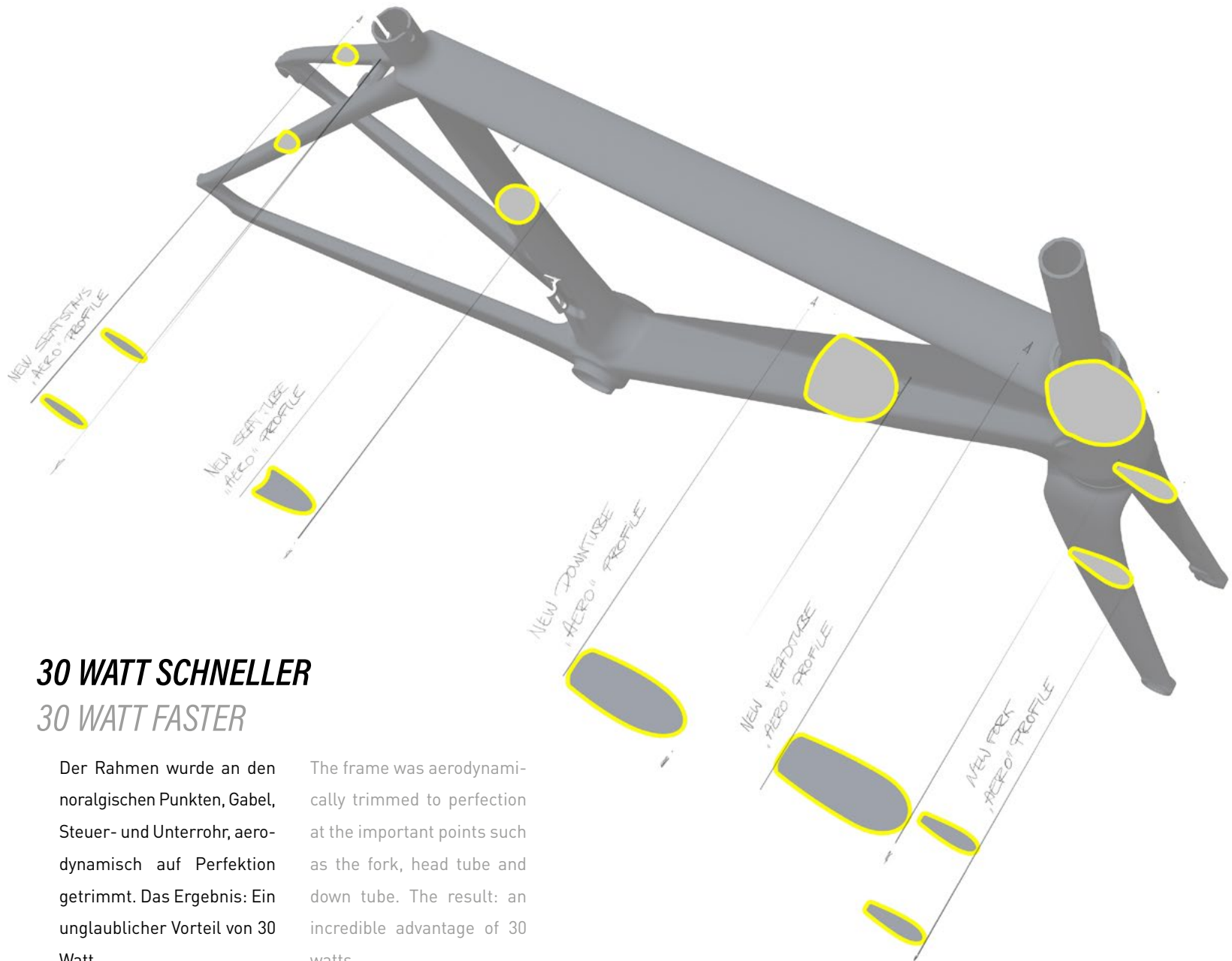

## **30 WATT SCHNELLER** 30 WATT FASTER

Der Rahmen wurde an den nervalgischen Punkten, Gabel, Steuer- und Unterrohr, aerodynamisch auf Perfektion getrimmt. Das Ergebnis: Ein unglaublicher Vorteil von 30 Watt.

The frame was aerodynamically trimmed to perfection at the important points such as the fork, head tube and down tube. The result: an incredible advantage of 30 watts.

# **UNSERE DEFINITION VON PERFEKTION** OUR DEFINITION OF PERFECTION

## **SHADOW** EDGE TUBE **3.0**

### **BIONIC** DESIGN

---

Technologie der Zukunft vereint in extravaganter Design – die neue bionische Rahmenkonstruktion von corratec erzeugt eine maximale Verwindungssteifigkeit des Unterrohrs und garantiert somit höchstmögliche Sicherheit für den Fahrer. Der Bosch PowerTube 750Wh Akku verschwindet zu 100% im Rahmen und integriert sich formschön in die exklusive Linienführung des Bionic Designs. Die neue Designgebung von corratec bietet somit weitreichende Vorteile beim Handling und Funktionalität in Verbindung mit dem Bosch Smart System.

Future innovations combined with an extravagant design – the new bionic frame construction of corratec provides maximum torsional rigidity of the down tube. Therefore the innovative frame ensures the highest grade of safety and functionality for our clients. The Bosch PowerTube 750Wh battery disappears 100% into the frame and is elegantly integrated into the unique shapes of the Bionic design. The new corratec Bionic Design offers a various number of advantages in handling combined with the new Bosch Smart System.

---





**INNOVATIONEN**  
— INNOVATIONS —

**"Weltweit stabilster und  
sicherster corrateg E-Bike  
Rahmen -  
DIE NÄCHSTE GENERATION"**

*"worldwide most stable and safest  
corrateg e-bike frame -  
THE NEXT GENERATION"*

# SHADOW 3.0 EDGE TUBE FEATURES

## BIONIC GRIP

Die bioinsche Struktur des Akkucovers bietet dem Fahrer beim Herausnehmen des Akkus besten Grip und verhindert somit ein Entgleiten aus der Hand. Das Handling wurde dadurch deutlich erleichtert. Der völlig im Rahmen integrierte Deckel überzeugt mit einer fließenden Linienführung und sorgt für eine cleane Optik.

The bioinic structure of the battery cover provides superior grip when removing the battery and prevents it from slipping out of the hand. This cover provides a much more easier handling. The lid, which is fully integrated into the frame, impresses with its flowing lines and ensures a clean look.

## BIONIC COOLING

Die speziell für das neue Shadow Edge 3.0 designten Lüftungsschlitze versorgen den Bosch Motor mit ausreichend Frischluft und vermeiden eine Überhitzung bei starker Belastung. Eine maximale Leistung des Motors auch bei steilen Anstiegen ist somit immer gewährleistet.

The ventilation slots are specially designed for the new Shadow Edge 3.0 and provides the strong Bosch engine with sufficient fresh air and prevent overheating. Therefore the engine ensures maximum power at any time.







## BIONIC SAFETY LOCK

Der speziell für das Shadow Edge Tube 3.0 entwickelte Verschlussmechanismus reduziert durch seine smarte Aufnahme den Ausschnitt des Unterrohrs und erhöht dadurch die Verwindungssteifigkeit des Rahmens um ein Vielfaches. Die doppelte Sicherung arretiert den Akku bombenfest im Schacht und verhindert somit ein Klappern oder selbstständiges Lösen während der

Fahrt.

The locking mechanism, specially developed for the Shadow Edge Tube 3.0, reduces the cutout of the down tube thanks to its smart mounting and thus increases the torsional stiffness of the frame. The double safety locks the battery firmly in the slot and prevents it from rattling or loosening while riding.

## STABILITY BIONIC & SAFETY

Eine zusätzliche Verstrebung, die in den Rahmen eingearbeitet wurde, erhöht die torsionale Steifigkeit des Unterrohrs um ein Vielfaches. Der Fahrer erhält dadurch maximale Kontrolle im schwierigen Gelände.

In order to increase the torsional rigidity of the down tube an additional bar has been integrated inside the frame. This feature ensures maximum control and safety.



# BETTER TOGETHER ...



## HUBERBUAM BERCHTESGADEN

Die Brüder Thomas und Alexander Huber, ein weltweit bekanntes Extrembergsteiger Duo, setzen auf Elektro. Beide haben ihre E-Mountainbikes von corratec erhalten, mit denen sie besonders schnell zum Einstieg ihrer nächsten Klettertour kommen.

The brothers Alexander and Thomas Huber, both extreme-mountaineers, rely on electric-power. Both ride corratec E-Bikes, with which they can reach the start of their climbing adventures fast and comfortably.

## KLITSCHKO BROTHERS

Die Brüder Wladimir und Vitali Klitschko begeistern sich beide in ihrer Freizeit für's Radfahren. Hierfür haben Sie sich persönlich von dem Rahmenbaumeister Mauro Sannino vermessen lassen, um später ihr maßgefertigtes Rad abzuholen.

The brothers Wladimir and Vitali Klitschko are both avid cyclers in their free time. Putting extreme demands on a bike for their height and weight, both chose to be measured and have a custom bike built by Mauro Sannino.





# CORRATEC PARTNER

— AMBASSADORS —

## DSV PREMIUM PARTNER



Die strategische Partnerschaft mit dem deutschen Skiverband verbindet unsere Premium Marke mit dem Spitzensport. Viele Profi Wintersport Athleten trainieren auf unseren corratec Bikes zur Vorbereitung für ihre Wettkämpfe.

The strategic partnership with the German ski association connects our premium brand with high class sport. Many professional winter sports athletes train on our bikes in preparation for their competitions.

## ADELHOLZENER PREMIUM PARTNER

Die Heimat der Adelholzener Alpenquellen sind die bayerischen Alpen. Hier stellt das Unternehmen Heilwasser, Mineralwasser und Erfrischungsgetränke her. Seit 2014 ist Adelholzener offizieller Kooperationspartner corratecs.

The home of Adelholzener Aplenquellen is in the bavarian alps. The company produces healing water, mineral water and soft drinks under the brand Adelholzener and Active 02. Since 2014 Adelholzender is an official partner of corratec.



# WAS IST DEINE MISSION? WHATS YOUR MISSION



Mit Deinem corratec urban Bike erreichst Du Deinen Arbeitsplatz oder das Kaffee Date absolut stressfrei und immer pünktlich! Mit Deinem Umweltbewusstsein leistest Du einen großen Beitrag zum Wandel in der urbanen Mobilität der Zukunft.

With your corratec urban bike you can reach your workplace or your coffee date absolutely stress-free and always on time! With your environmental awareness you are making a major contribution to the change in urban mobility of the future.



Traumhafte Landschaften und kulinarische Genüsse auf eher langen Touren, auch mal mit Gepäck, haben bei Dir oberste Priorität. Lass Dich Inspirieren und entdecke die schönsten Regionen auf Deinem corratec Traumbike.

Fantastic landscapes and culinary delights on rather long tours, sometimes with luggage, are your top priority. Let yourself be inspired and discover the most beautiful regions on your dream bike.





# SPORT

Du definierst Dich selbst als sportlich ambitionierter Radfahrer, suchst die persönliche Challenge und bist für jedes Abenteuer im Gelände oder auf der Straße zu haben! Deine Passion treibt Dich immer wieder an neue Touren zu testen und neue Levels zu definieren.

You define yourself as a sporty, ambitious cyclist, you are looking for a personal challenge and you are always ready for any adventure in the field or on the road! Your passion drives you to test new tours and to define new levels again and again.



# PERFORMANCE

Höchstleistung ist Deine Devise. Die maximale Leistung Dein oberstes Ziel. Ein superleichtes Corratec Rahmenset kombiniert mit hochwertigsten Komponenten ist für Dich die grundlegende Voraussetzung für den persönlichen Erfolg.

Top performance is your motto. Maximum performance is the ultimate goal. A super light Corratec frame set combined with high quality components is the basic requirement for your personal success.



# EINSATZBEREICHE

## RANGE OF USE



Hierbei handelt es sich in der Regel um Kinderräder der Größe 12 und 16 Zoll, bestens geeignet für Kinder ab 3 Jahren. Diese Bikes sollten nur unter Aufsicht eines Erziehungsberechtigten und nicht im öffentlichen Verkehr eingesetzt werden.

These are usually 12 and 16 inch children's bikes, ideally suited for children from 3 years of age. These bikes should only be used under the supervision of a legal guardian and not in public transport.

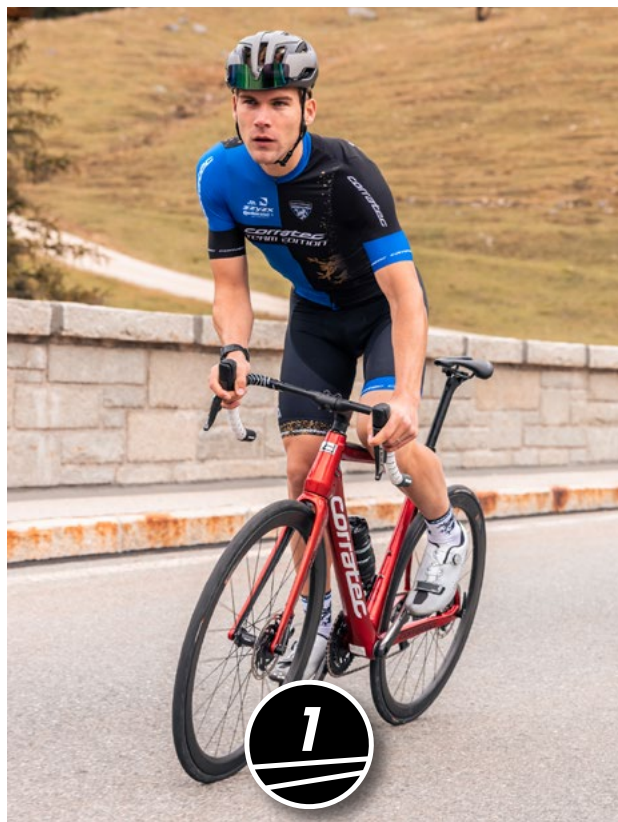

In diesem Bereich findest Du Fahrräder und Pedelecs des Typs Rennrad, Fitness und Urban. Diese Art von Bikes eignen sich hervorragend für asphaltierte Straßen und Wege, jedoch nicht für Drops, Sprünge oder Gelände.

In this area you will find bicycles and pedelecs of the racing, fitness and urban types. These types of bikes are great for paved roads and trails, but not suited for drops and jumps or extreme terrain.



Hier klassifiziert sind Fahrräder und Pedelecs des urbanen Bereichs und Stadtverkehrs. Sie unterstützen Dich als zuverlässigen Partner bei Deinen täglichen Pendelfahrten zur Arbeit oder in der Freizeit.

Bicycles and pedelecs in urban areas and city traffic are classified here. They support you as a reliable partner on your daily commute to work or in your free time.





Hier klassifiziert sind Fahrräder und Pedelecs des Typs Mountainbike, Gravel und all Track. Sie bieten Dir beste Performance in der Zielgruppe Cross Country, Marathon und Tour.

Bicycles and pedelecs of the mountain bike, gravel and all track types are classified here. They offer you the best performance in the target group cross country, marathon and tour.

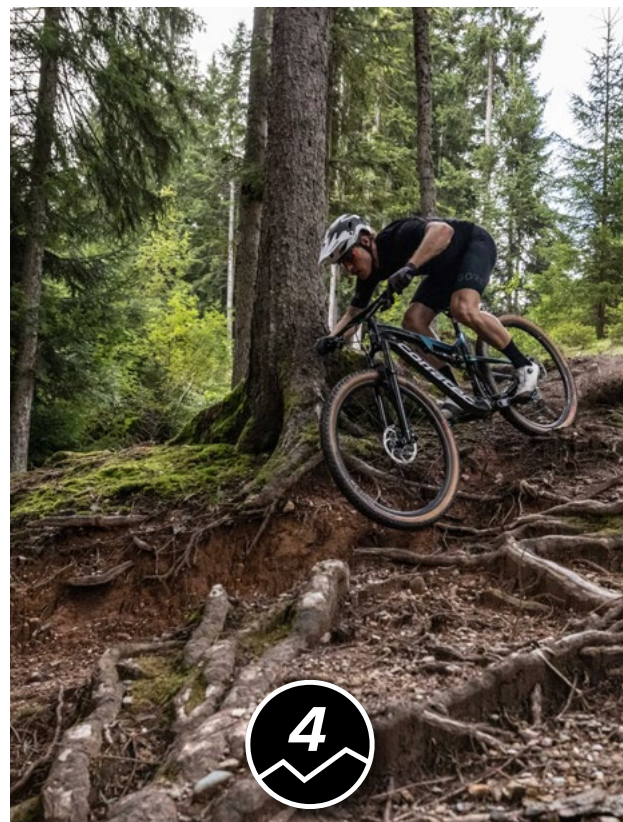

Um optimale Bedingungen für den Einsatzbereich Allmountain zu garantieren, ist ein Fahrrad oder ein (S) Pedelec dieser Kategorie empfehlenswert.

In order to guarantee optimal conditions for all-mountain use, a bicycle or an (S) pedelec of the mountain bike type of this category is recommended.



Fahrräder bzw. (S-) Pedelecs für extremes Gelände verlangt von den Fahrrädern bzw. (S-) Pedelecs höchste Anforderungen. Diese Art der Räder sind für den Bereich Enduro, Freeride und Downhill geeignet.

Bicycles or (S-) pedelecs for extreme terrain demand the highest standards from bicycles and (S-) pedelecs. This type of bike is suitable for enduro, freeride and downhill applications.



#### EPS

Normalerweise werden bei der Herstellung eines Carbonrahmens Ballons verwendet. Bei dieser Technik entstehen allerdings Falten im Inneren des Rahmens, oder die Oberfläche ist ungleichmäßig. Expandiertes Polystyriol (EPS) hingegen dehnt sich bei Hitze aus und drückt von Innen gegen das Carbon. Das Ergebnis ist ein leichter, steiferer und gleichmäßiger Rahmen.

—



#### SUPER LIGHT

Mitsubishi stellt weltweit die hochwertigsten Carbonfasern in Japan her. Dieses Super Light Carbon ermöglicht durch materialgerechte Konstruktion, Verarbeitung und Behandlung extrem feste und hoch belastbare Bauteile mit sehr geringem Gewicht.

—



#### 26" WHEEL SIZE

26 Zoll Laufradgröße ist besonders für kleine Personen, welche ein sehr wendiges Bike suchen, geeignet.

—



#### 650B WHEEL SIZE

650B Laufradgröße ist der neue MTB Standard. Das 650B Laufrad ist kein Kompromiss aus 26 und 29 Zoll. Es vereint in sich die Vorteile von 26 Zöllern (Gewicht, Torsionsteifigkeit und Agilität) mit den Vorteilen des 29" Laufrades (erhöhte Laufruhe, Überrollverhalten, erhöhte Kurvenstabilität).

—



#### 28" WHEEL SIZE

28 Zoll rollen leichter als die 26-Zoll-Variante. Das 28" Rad benötigt zwar länger, um in Schwung zu kommen, rollt aber leichter und schneller über Steine und Wurzeln, was noch einen zusätzlichen Vorteil bringt – mehr Komfort.

—



#### WHEELSIZE SPLIT

Vorne 29 Zoll Laufräder, Hinten 650B + Bereifung. Die perfekte Kombination aus Rolleigenschaften, Handling und Agilität.

#### EPS

Traditionally, inflatable balloons are used inside the carbon frame to force the material into the mould, but this technique leaves wrinkles or inconsistent thickness. To avoid this, we use expanded polystyrene. When heated, this material swells and exerts pressure on the inside of the carbon fibre. The result is a lighter, stiffer and more consistent final product.

—

#### SUPER LIGHT

Mitsubishi provides the highest quality carbon fiber around the world. The resulting superlight Carbon allows extremely strong and highly durable components with very low weight through material-appropriate construction, processing and treatment.

—

#### 26" WHEEL SIZE

26" wheel size is suitable for shorter people who are looking for a very versatile bike.

—

#### 650B WHEEL SIZE

650B wheel size is the new MTB standard. The 650B wheel is not a compromise between 26 and 29". It combines the advantages of 26-inch models (weight, torsional stiffness and agility) with the advantages of the 29" impeller (increased smoothness, rollover behavior, increased cornering stability).

—

#### 28" WHEEL SIZE

28 inch roll easier than the 26-inch version. The 28" wheel takes longer to get going, but rolls easily and quickly over rocks and roots, which still brings an additional advantage – more comfort.

—

#### WHEELSIZE SPLIT

At the front 29 inch wheels, at the rear 650b + tires. The perfect combination of The perfect combination of rolling characteristics, handling and agility.



#### 29" WHEEL SIZE

Große Laufräder rollen besser. 29 Zoll mit etwa acht Prozent weniger Energieaufwand als die 26-Zoll-Variante. Das 29" Rad benötigt zwar länger, um in Schwung zu kommen, rollt aber leichter und schneller über Steine und Wurzeln, was noch einen zusätzlichen Vorteil bringt – mehr Komfort.

—



#### HOLLOW CORE TECH

HCT (Hollow Core Technology) ist eine high-tech Aluminium Konstruktions-technologie. Anstatt schwere, überproportionierte Winkelstücke zu verwenden, nutzen wir komplexe Konstruktionen, welche sowohl Gewicht sparen als auch die allgemeine Stabilität erhöhen.

—



#### PRESS FIT BB

Das Press Fit Lager ist leichter und durch den größeren Durchmesser des Kurbelgehäuses auch stabiler als herkömmliche Innenlager. Ausgeschlagene Gewinde gehören der Vergangenheit an.

—



#### DI2 READY

Der Rahmen ist standardmäßig schon auf die elektronische Schaltung von Shimano vorbereitet, falls Sie später auf diesen neuen Schaltungstyp umrüsten wollen.

—



#### STEM ADJUSTMENT

Der Vorbau ist vielseitig verstellbar. Durch Verstellung des Vorbauwinkels werden sowohl der Abstand Oberkörper zu Lenker, als auch die Lenkerhöhe verändert. Wer schmerzfrei fährt, fährt länger.

—



#### HANDLEBAR STABILIZER

Seitlich im Lenker angebrachte Gewichte minimieren die auftretenden Vibrationen und sorgen für mehr Stabilität bei hohen Geschwindigkeiten.

#### 29" WHEEL SIZE

Large wheels roll better. 29 inches require about eight percent less energy than the 26-inch version. The 29" wheel takes longer to get going, but rolls easily and quickly over rocks and roots, which brings an additional advantage – more comfort.

—

#### HOLLOW CORE TECH

HCT (Hollow Core Technology) is pure high-tech. Instead of using heavy oversized gussets we looked for the perfect construction. This enormously complex process saves a lot of weight while increasing stability.

—

#### PRESS FIT BB

The Press Fit bottom bracket is lighter and through the larger diameter of the crank also more stable than a traditional bottom bracket. Worn out threads are a thing of the past.

—

#### DI2 READY

The frame is by default already prepared for the electronic gear shifting of Shimano, in case you want to update to this new type of gear shifting at a later point.

—

#### STEM ADJUSTMENT

The stem is fully adjustable. By adjusting the stem angle, both the distance upper body to handlebars, and the handlebar height are adjusted. Enjoy your long and pain free ride.

—

#### HANDLEBAR STABILIZER

Weights mounted inside the handlebar will minimize the vibrations that occur and provide more stability at high speeds.





#### SUSPENSION SEATPOST

Die gefederte Sattelstütze bietet höchsten Komfort. Die Federhärte lässt sich auf Ihre Bedürfnisse einstellen.

—



#### HYBRID

Ein Pedelec (Pedal Electric Cycle) ist eine spezielle Ausführung eines Elektrofahrrades, bei dem der Fahrer von einem Elektroantrieb unterstützt wird, wenn er pedaliert.

—



#### TAPERED HEADTUBE

Das Steuerrohr ist speziell verstärkt um auftretenden Kräfte besser aufnehmen zu können.

—



#### C-LIGHT

Ein integriertes Tagfahrlicht um im Straßenverkehr noch besser gesehen zu werden.

—



#### DROPPER SEATPOST

Teleskopsattelstütze mit Bedienhebel am Lenker oder an der Sattelstütze.

—



#### INTERNAL CABLE ROUTING

Kabelverlegung im Inneren des Rahmens, zum Schutz und für ein elegantes Design.

—



#### OPTIMIZED FOR DOUBLE

Die Kinematik des Bikes ist für 2-fach Kettenradgarnituren konstruiert und optimiert.

—



#### THROUGH AXLE

„Trough Axle“ haben den Vorteil, dass sie einen größeren Durchmesser als herkömmliche 9-mm-Achsen haben und so wesentlich steifer sind.

—



#### 180 KG SYSTEMGEWICHT

Dank Shadow Edge Tube Technologie verfügt das Bike über den weltweit stabilsten und sichersten corratec E-Bike Rahmen und kann mit bis zu 180 Kg Systemgewicht belastet werden.

#### SUSPENSION SEATPOST

The suspension seatpost offers great comfort. The spring rate can be adjusted to your needs.

—

#### HYBRID

A pedelec (Pedal Electric Cycle) is a special version of an electric bicycle, in which the rider is assisted by an electric drive when pedaling.

—

#### TAPERED HEADTUBE

The head tube is specially reinforced to accommodate force more efficiently.

—

#### C-LIGHT

An integrated daylight to be seen in the daily traffic.

—

#### DROPPER SEATPOST

Dropper Seatpost with control lever on the handlebar or seatpost.

—

#### INTERNAL CABLE ROUTING

Internal Cable Routing inside the frame for protection and a stylish design.

—

#### OPTIMIZED FOR DOUBLE

The kinematic is designed and optimized for double chainrings.

—

#### THROUGH AXLE

Through-axes have the advantage that they are larger in diameter than conventional 9 mm axles and thus are significantly stiffer.

—

#### 180 KG SYSTEMWEIGHT

The bike exhibits the worldwide most stable and safest corratec E-Bike frame and can carry up to a total of 180 kg system weight.

# TECHNOLOGIEN —TECHNOLOGIES—

## TECHNIK MACHT DEN UNTERSCHIED TECHNOLOGY MAKES THE DIFFERENCE

Seit vielen Jahren begeistern wir unsere Kunden, erstaunen andere Wettbewerber und rufen Nachahmer hervor. Kaum ein anderes Produkt trägt so viele nützliche Features und Innovationen in sich wie ein corratec Bike. Dies spürst Du bei jeder Pedalumdrehung.

For many years we have been inspiring our customers, astounding competitors and evoke imitators. Hardly any other product carries as many useful innovations as a corratec bike. You feel the passion with every pedal turn.



# THE E-MOUNTAINBIKE

Raus aus dem Alltag und rein ins Grüne! Mit unseren E-MTBs garantieren wir Dir neue Abenteuer und Faszination pur. Bergauf auf befestigten Wegen oder bergab auf anspruchsvollen Trails bieten wir Dir jede Menge Spaß und Sicherheit. Mit unseren superleichten E-MTB Fullys und Hardtails erzielst Du maximale Performance, Dynamik und kommst sicher über die Alpen. Neueste Technologien um neue Grenzen zu setzen.

Get out of everyday life and into the countryside! With our E-MTBs we bring you to new adventures and provide pure fascination. Uphill on steep climbs or downhill on demanding trails, we offer you a lot of fun and safety. With our superlight E-MTB fullys and hardtails you will achieve maximum performance to get across the Alps safely. In addition all E-Bikes contains latest technologies to set new limits.

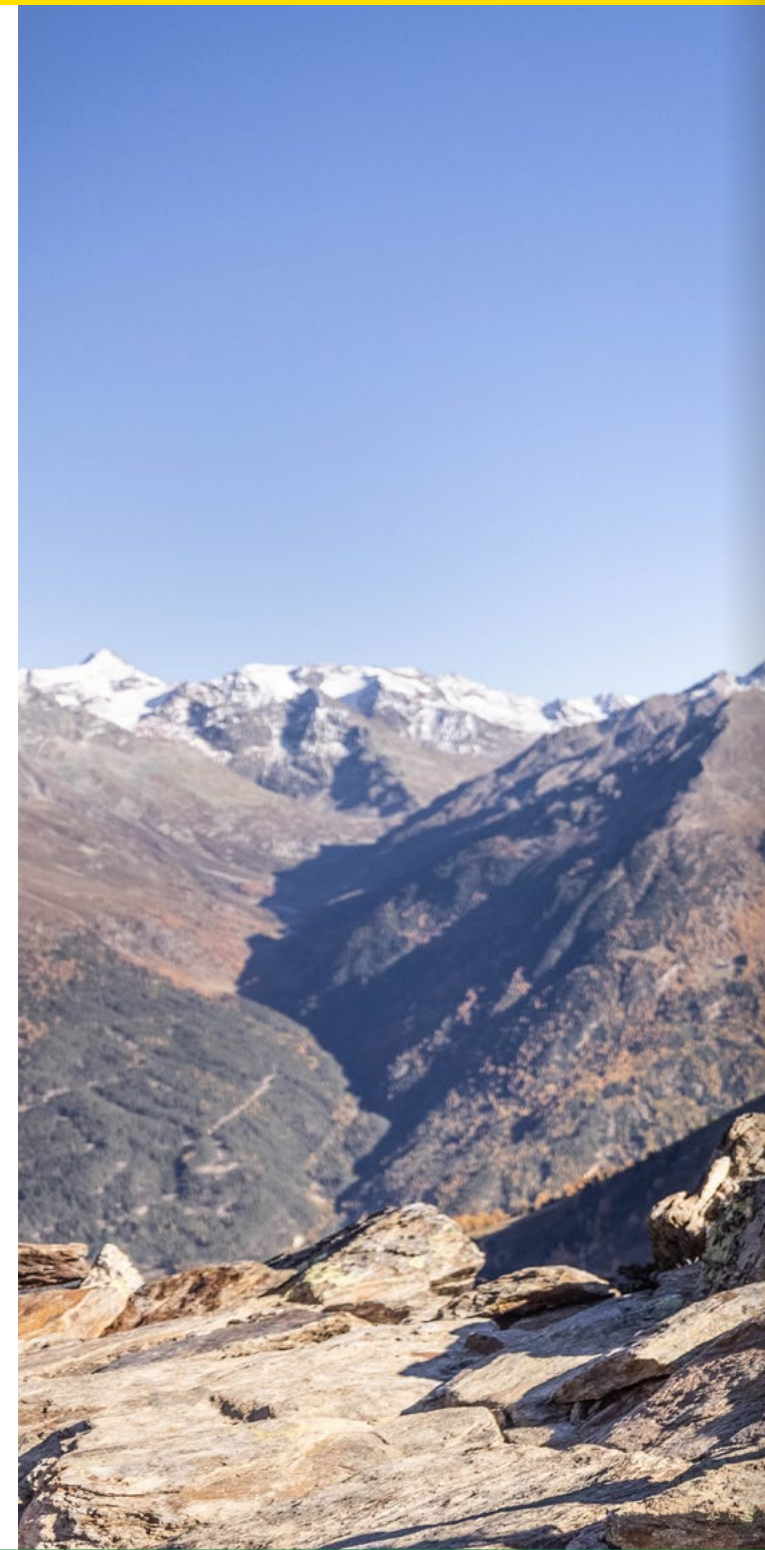







# E-POWER iLINK 180



# 3.345<sub>GR</sub>

Voll Carbon Rahmen  
Full Carbon Frame

---

## iLINK

Maximaler Vortrieb  
und Traktion

Maximum propulsion  
and traction

---

# 180<sub>MM</sub>

Maximale Federung bei  
maximalen Vortrieb

Maximum suspension with  
maximum propulsion





## iLINK TECHNOLOGIE

Diese einzigartige Innovation, zu 100% im Hause corrateg konstruiert und entwickelt, ermöglicht es Dir Deinen Hinterbau und Dämpfer zu jeder Zeit auch uphill, geöffnet zu lassen.

**Automatischer Lockout - Maximaler Vortrieb - Bessere Traktion**

This unique innovation, 100% designed and developed by corrateg, enables you to keep your rear shock open at all times, even uphill.

**Automatic lockout - Maximum traction - Increasing propulsion**

## SMART CHARGE SYSTEM

Die brandneue, im Oberrohr des Rahmens integrierte Ladebuchse erleichtert Dir das Laden Deines Akkus und ist dazu noch ein echter Hingucker.

The brand new charging socket integrated in the top tube of the frame makes it easier for you to charge your battery and creates a cleaner look of your bike.

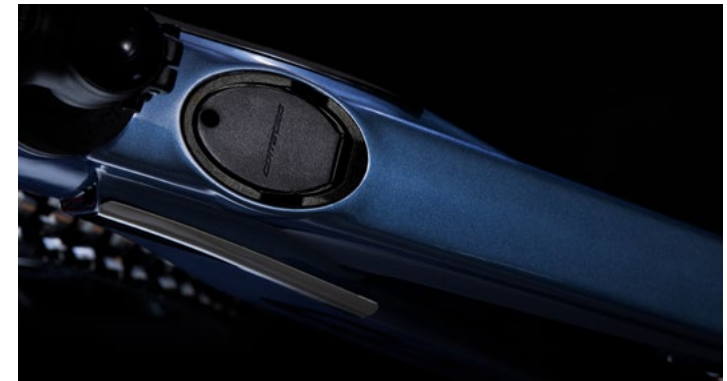

## SHADOW EDGE TUBE 2.0

Eine weitere geniale Innovation von corrateg ist der ultraleichte und formschöne Carbon Rahmen und Hinterbau. Diese Technologie erzeugt beim Fahren trotz komplett integriertem Akku, eine höchstmögliche Verwindungssteifigkeit und garantiert maximale Sicherheit in jedem Gelände.

Another ingenious innovation from corrateg is the ultra light and elegant carbon frame including the rear end. This technology creates the highest possible torsional rigidity despite fully integrated battery and ensures maximum safety on any surface .



# E-POWER iLINK 180 FACTORY

Ultraleichter Carbon Rahmen inklusive Carbon Hinterbau mit 180mm Federweg.

Alle herausragenden Features der iLink Technologie nun auch im E-Bike.

Shadow Edge Tube 2.0 - weltweit stabilster und sicherster corrated E-Bike Rahmen mit vollintegriertem 625Wh Akku.

Ultralight carbon frame including carbon - rear triangle with 180mm travel.

A downhill machine that ensures amazing pleasure on all trails of the world.

Shadow Edge Tube 2.0 - worldwide most stable and safest corrated E-Bike frame.

- Bosch Performance CX Race
- Bosch Power Tube 625Wh
- Bosch Kiox 300
- E-Power iLink 180 Boost
- Rockshox FS ZEB Ultimate RC2 29" 180mm
- Rockshox Super Deluxe Ultimate 205 x 65
- Sram X01 Eagle AXS Red 12S
- Sram GX AXS Eagle 12S
- Sram G2 RSC 203mm I Front
- Sram G2 RSC 203mm I Rear
- Sram X-Sync 34T
- Sram XG1295 Eagle 10-50T 12S
- Sram XX1 Eagle Rainbow 12S
- DT Swiss HX 1501 Spline 29" I Front
- DT Swiss HX 1501 Spline 650B I Rear
- Michelin E-Wild 29" x 2.60 I Front
- Michelin E-Wild 650B x 2.80 I Rear
- Selle San Marco Gnd Full-fit
- Rockshox Reverb AXS 31.6mm
- ZZYZX SL Alloy Stem
- ZZYZX SL Alloy Handlebar



**iLINK**  
**180**  
**SE**  
**20**  
**625**  
**Wh**  
**85**  
**Nm**

The Rendering is for Reference only

**FARBE COLOR**

Factory Copper | Pearlized Black

**BK28410**

**42 | 48 | 52**

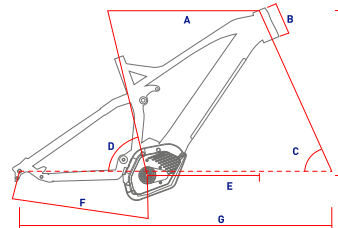

**E-POWER iLINK 180 BOOST | SHADOW EDGE TUBE 2.0**

CM	A	B	C	D	E	F	G	H
42	599	85	64	76	1236	444	455	615
48	610	96	64	76	1248	444	465	621
52	622	105	64	76	1262	444	475	629

**FEATURES**





# E-POWER iLINK 180 FACTORY 45

Ultraleichter Carbon Rahmen inklusive Carbon Hinterbau mit 180mm Federweg.





Alle herausragenden Features der iLink Technologie nun auch im E-Bike.

Shadow Edge Tube 2.0 - weltweit stabilster und sicherster corrated E-Bike Rahmen mit vollintegriertem 625Wh Akku.

Ultralight carbon frame including carbon - rear triangle with 180mm travel.

A downhill machine that ensures amazing pleasure on all trails of the world.

Shadow Edge Tube 2.0 - worldwide most stable and safest corrated E-Bike frame.

-  Bosch Performance Speed (45 km/h / 28 mph)
-  Bosch Power Tube 625Wh
-  Bosch Kiox 300
-  E-Power iLink 180 Boost
-  Rockshox FS ZEB Ultimate RC2 29" 180mm
-  Rockshox Super Deluxe Ultimate 205 x 65
-  Sram X01 Eagle AXS Red 12S
-  Sram GX AXS Eagle 12S
-  Sram G2 RSC 203mm I Front
-  Sram G2 RSC 203mm I Rear
-  Sram X-Sync 34T
-  Sram XG1295 Eagle 10-50T 12S
-  Sram XX1 Eagle Rainbow 12S
-  DT Swiss HX 1501 Spline 29" I Front
-  DT Swiss HX 1501 Spline 650B I Rear
-  Michelin 29" x 2.60 E-Wild I Front
-  Michelin 27.5" E-Wild I Rear
-  Selle Italia Model X W 145
-  Rockshox Reverb AXS 31.6mm
-  ZZZZX SL Alloy Stem
-  ZZZZX SL Alloy Handlebar



**iLINK**  
**180**  
**SE**  
**20**  
**625**  
**Wh**  
**85**  
**Nm**

The Rendering is for Reference only

FARBE COLOR



Factory Copper I Pearlized Black

**BK28413**

42 | 48 | 52

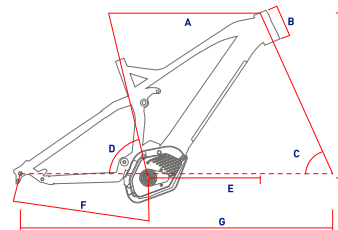

**E-POWER iLINK 180 BOOST I SHADOW EDGE TUBE 2.0**

CM	A	B	C	D	E	F	G	H
42	599	85	64	76	1236	444	455	615
48	610	96	64	76	1248	444	465	621
52	622	105	64	76	1262	444	475	629

**FEATURES**



# E-POWER iLINK 180 PRO

Ultraleichter Carbon Rahmen inklusive Carbon Hinterbau mit 180mm Federweg.





















Alle herausragenden Features der iLink Technologie nun auch im E-Bike.

Shadow Edge Tube 2.0 - weltweit stabilster und sicherster corrated E-Bike Rahmen mit vollintegriertem 625Wh Akku.

Ultralight carbon frame including carbon - rear triangle with 180mm travel.

A downhill machine that ensures amazing pleasure on all trails of the world.

Shadow Edge Tube 2.0 - worldwide most stable and safest corrated E-Bike frame.

-  Bosch Performance CX Race
-  Bosch Power Tube 625Wh
-  Bosch Kiox 300
-  E-Power iLink 180 Boost
-  Rockshox FS ZEB Select RC 29" 180mm
-  Rockshox Super Deluxe Select 205 x 65
-  Sram X01 Eagle Red 12S
-  Sram GX Eagle 12S
-  Sram G2 R 203mm
-  Sram G2 RSC 203mm
-  Sram X-Sync 34T
-  Sram XG1275 Eagle 10-50T 12S
-  Sram SX Eagle 12S
-  DT Swiss H1900 Spline 29" I Front
-  DT Swiss H1900 Spline 650B I Rear
-  Michelin E-Wild 29" x 2.60 I Front
-  Michelin E-Wild 650B x 2.80 I Rear
-  Selle San Marco Gnd Full-fit
-  Kindshock 900i 30.9mm
-  ZZZZX SL Alloy Stem
-  ZZZZX SL Alloy Handlebar



**iLINK**  
180  
**SE**  
20  
**625**  
Wh  
**85**  
Nm

The Rendering is for Reference only

FARBE COLOR

 Factory Copper | Pearlized Black

**BK28411**

 42 | 48 | 52

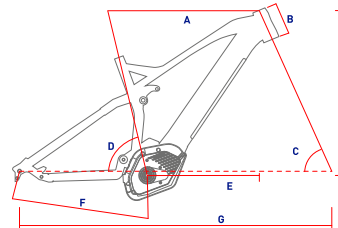

**E-POWER iLINK 180 BOOST | SHADOW EDGE TUBE 2.0**

CM	A	B	C	D	E	F	G	H
42	599	85	64	76	1236	444	455	615
48	610	96	64	76	1248	444	465	621
52	622	105	64	76	1262	444	475	629

**FEATURES**

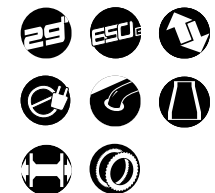



# E-POWER iLINK 180 RACE

Ultraleichter Carbon Rahmen inklusive Carbon Hinterbau mit 180mm Federweg.





















Alle herausragenden Features der iLink Technologie nun auch im E-Bike.

Shadow Edge Tube 2.0 - weltweit stabilster und sicherster corrated E-Bike Rahmen mit vollintegriertem 625Wh Akku.

Ultralight carbon frame including carbon - rear triangle with 180mm travel.

A downhill machine that ensures amazing pleasure on all trails of the world.

Shadow Edge Tube 2.0 - worldwide most stable and safest corrated E-Bike frame.

-  Bosch Performance CX Race (25 km/h)
-  Bosch Power Tube 625Wh
-  Bosch Kiox 300
-  E-Power iLink 180 Boost
-  Rockshox FS Yari RC 29" 180mm
-  Rockshox Super Deluxe Select 205 x 65
-  Sram GX Eagle 12S
-  Sram NX Eagle 12S
-  Sram Guide T 203mm I Front
-  Sram Guide T 203mm I Rear
-  Sram X-Sync 34T
-  Sram PG1210 Eagle 11-50T 12S
-  Sram SX Eagle 12S
-  ZYZX Cross Attack 29" I Front
-  ZYZX Cross Attack 650B I Rear
-  Michelin E-Wild 29" x 2.60 I Front
-  Michelin E-Wild 650B x 2.80 I Rear
-  Selle San Marco Gnd Full-fit
-  Kindshock 900i 31.6mm
-  ZYZX SL Alloy Stem
-  ZYZX SL Alloy Handlebar



**iLINK**  
**180**  
**SE**  
**20**  
**625**  
**Wh**  
**85**  
**Nm**

E-BIKE

The Rendering is for Reference only

**FARBE COLOR**  Factory Copper | Pearlized Black

**BK28412**

 42 | 48 | 52

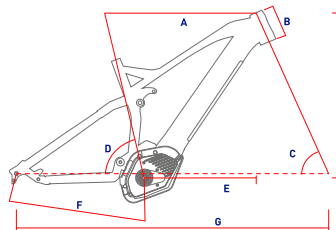

**E-POWER iLINK 180 BOOST | SHADOW EDGE TUBE 2.0**

CM	A	B	C	D	E	F	G	H
42	599	85	64	76	1236	444	455	615
48	610	96	64	76	1248	444	465	621
52	622	105	64	76	1262	444	475	629

**FEATURES**





# E-POWER RS 160 FACTORY

Der Triple Butted Aluminium Rahmen sorgt für ein leichtes und stabiles E-Bike.

Die Shadow Edge Tube 3.0 Technologie gibt dem Rahmen höchstmögliche Steifigkeit.

Die spezielle Allmountain Geometrie eignet sich optimal für lange Touren im Gelände.

High-quality frame with triple butted aluminum for a light and stiff E-Bike.

Shadow Edge Tube 3.0 – worldwide most stable and safest corrated E-Bike frame with integrated battery.

The special all-mountain geometry fits perfectly for long tours across the alps.

- Bosch Performance CX Cruise BES3 (25 km/h)
- Bosch Power Tube 750Wh
- Bosch Kiox 300
- E-Power RS 160 Boost
- Rockshox FS ZEB Ultimate RC2 29" BOOST 160mm
- Rockshox Super Deluxe Ultimate RCT 205 x 65
- Sram GX Eagle 12S
- Sram GX Eagle 12S
- Sram G2 R 203mm I Front
- Sram G2 R 203mm I Rear
- Sram X-Sync 34T
- Sram XG1275 Eagle 10-50T 12S
- Sram SX Eagle 12S
- Mavic E-Deemax S30 29" I Front
- Mavic E-Deemax S30 650B I Rear
- Michelin E-Wild 29" x 2.60 I Front
- Michelin E-Wild 650B x 2.80 I Rear
- Selle San Marco Gnd Full-fit
- Kindshock 900i 30.9mm
- ZZYZX SL Alloy Stem
- ZZYZX SL Alloy Handlebar



## E-RS 160

# SE

3.0

# 750

Wh

# 85

Nm

The Rendering is for Reference only

FARBE COLOR

Factory Copper | Pearlized Black

**BK28420**

39 | 42 | 47 | 52

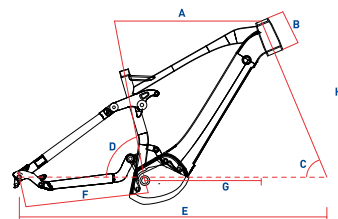

**E-POWER RS 160 BOOST | SHADOW EDGE TUBE 3.0**

CM	A	B	C	D	E	F	G	H
39	612	145	65	74	1223	449	425	655
42	632	145	65	74	1243	449	445	655
47	654	150	65	74	1265	449	465	659
52	658	160	65	74	1289	449	485	668

**FEATURES**

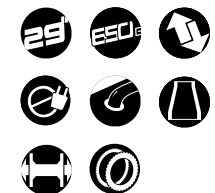





# E-POWER RS 160 PRO TEAM

Der Triple Butted Aluminium Rahmen sorgt für ein leichtes und stabiles E-Bike.



Die Shadow Edge Tube 3.0 Technologie gibt dem Rahmen höchstmögliche Steifigkeit.

Die spezielle Allmountain Geometrie eignet sich optimal für lange Touren im Gelände..

High-quality frame with triple butted aluminum for a light and stiff E-Bike.

Shadow Edge Tube 3.0 – worldwide most stable and safest corrated E-Bike frame with integrated battery.

The special all-mountain geometry fits perfectly for long tours across the alps.

-  Bosch Performance CX Cruise BES3 (25 km/h)
-  Bosch Power Tube 750Wh
-  Bosch Kiox 300
-  E-Power RS 160 Boost
-  Rockshox FS Yari RC 29" 160mm
-  Rockshox Deluxe Select+
-  Shimano Deore XT SGS 12S
-  Shimano SLX 12S
-  Shimano MT420 203mm I Front
-  Shimano MT420 203mm I Rear
-  ZZYZX E-Power Crank 34T
-  Shimano SLX 10-51T 12S
-  KMC X12 12S
-  ZZYZX X30 29" I Front
-  ZZYZX X30 650B I Rear
-  Michelin E-Wild 29" x 2.60 I Front
-  Michelin E-Wild 650B x 2.80 I Rear
-  Selle Italia Model X3 XP BOOST Superflow
-  Kindshock 900i 30.9mm
-  ZZYZX SL Alloy Stem
-  ZZYZX SL Alloy Handlebar



## E-RS 160

# SE<sup>3.0</sup>

# 750<sup>Wh</sup>

# 85<sup>Nm</sup>

The Rendering is for Reference only

**FARBE COLOR**  Pearlized Black | Light Blue | Mango

**BK28421**

 39 | 42 | 47 | 52

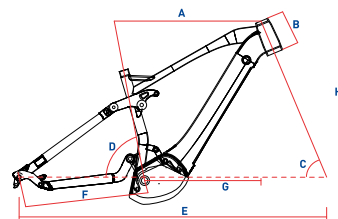

**E-POWER RS 160 BOOST | SHADOW EDGE TUBE 3.0**

CM	A	B	C	D	E	F	G	H
39	612	145	65	74	1223	449	425	655
42	632	145	65	74	1243	449	445	655
47	654	150	65	74	1265	449	465	659
52	658	160	65	74	1289	449	485	668

**FEATURES**

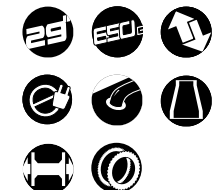



# E-POWER RS 160 PRO

Der Triple Butted Aluminium Rahmen sorgt für ein leichtes und stabiles E-Bike.

Die Shadow Edge Tube 2.0 Technologie gibt dem Rahmen höchstmögliche Steifigkeit.

Die spezielle Allmountain Geometrie eignet sich optimal für lange Touren im Gelände.

High-quality frame with triple butted aluminum for a light and stiff E-Bike.

Shadow Edge Tube 2.0 – worldwide most stable and safest corrated E-Bike frame with integrated battery.

The special all-mountain geometry fits perfectly for long tours across the alps.

-  Bosch Performance CX Cruise BES3 (25 km/h)
-  Bosch Power Tube 625Wh
-  Bosch Intuvia 100
-  E-Power RS 160 Boost
-  SR Suntour Durolux 36 RC2 160mm
-  SR Suntour TRIAir2
-  L-TW00 A12-X 12S
-  L-TW00 A12-X 12S
-  Shimano MT420 203mm I Front
-  Shimano MT420 203mm I Rear
-  ZYZX E-Power Crank 34T
-  L-TW00 A12 11-50T 12S
-  KMC X12 12S
-  ZYZX X30 29" I Front
-  ZYZX X30 650B I Rear
-  Michelin E-Wild 29" x 2.60 I Front
-  Michelin E-Wild 650B x 2.80 I Rear
-  Selle ItaliaX3 XP BOOST Superflow
-  Kindshock 900i 30.9mm
-  ZYZX SL Alloy Stem
-  ZYZX SL Alloy Handlebar



**E-RS 160**

**SE**  
20

**625**  
Wh

**85**  
Nm

E-BIKE

The Rendering is for Reference only

FARBE COLOR

 Light Sand | Dark Red | Pearlized Black

**BK28422**

 39 | 42 | 47 | 52

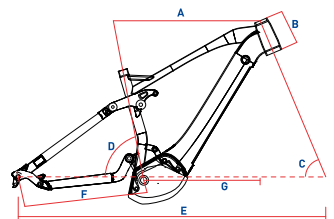

**E-POWER RS 160 BOOST | SHADOW EDGE TUBE 2.0**

CM	A	B	C	D	E	F	G	H
39	612	145	65	74	1223	449	425	655
42	632	145	65	74	1243	449	445	655
47	654	150	65	74	1265	449	465	659
52	658	160	65	74	1289	449	485	668

**FEATURES**



# E-POWER RS 160 ELITE

Der Triple Butted Aluminium Rahmen sorgt für ein leichtes und stabiles E-Bike.

Die Shadow Edge Tube 2.0 Technologie gibt dem Rahmen höchstmögliche Steifigkeit.

Die spezielle Allmountain Geometrie eignet sich optimal für lange Touren im Gelände.

High-quality frame with triple butted aluminum for a light and stiff E-Bike.

Shadow Edge Tube 2.0 – worldwide most stable and safest corrated E-Bike frame with integrated battery.

The special all-mountain geometry fits perfectly for long tours across the alps..

-  Bosch Performance CX Cruise BES3 (25 km/h)
-  Bosch Power Tube 625Wh
-  Bosch Intuvia 100
-  E-Power RS 160 Boost
-  SR Suntour AION EVO 35-Boost 160mm
-  SR Suntour EDGE LOR
-  Sram SX Eagle 12S
-  Sram SX Eagle 12S
-  Tektro HDM-275 203mm I Front
-  Tektro HDM-275 203mm I Rear
-  Sram X-Sync 34T
-  Sram PG1210 Eagle 11-50T 12S
-  Sram SX Eagle 12S
-  ZYZX X30 29" I Front
-  ZYZX X30 650B I Rear
-  Michelin E-Wild 29" x 2.60 I Front
-  Michelin E-Wild 650B x 2.80 I Rear
-  Selle Italia X3 XP BOOST Superflow
-  Kindshock 900i 30.9mm
-  ZYZX SL Alloy Stem
-  ZYZX SL Alloy Handlebar



## E-RS 160

# SE<sup>20</sup>

# 625<sup>Wh</sup>

# 85<sup>Nm</sup>

The Rendering is for Reference only

FARBE COLOR

 Tactic Green | Silver Gray

**BK28423**

 39 | 42 | 47 | 52

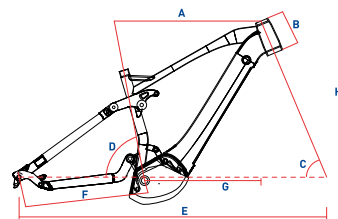

E-POWER RS 160 BOOST | SHADOW EDGE TUBE 2.0

CM	A	B	C	D	E	F	G	H
39	612	145	65	74	1223	449	425	655
42	632	145	65	74	1243	449	445	655
47	654	150	65	74	1265	449	465	659
52	658	160	65	74	1289	449	485	668

FEATURES











# E-POWER X VERT FACTORY

Komfort und Grip dank Wheel Split – vorne 29 Zoll Reifen und hinten 650B+.

Trail Hardtail mit 140mm Federweg und einem flacheren Lenkwinkel.

Shadow Edge Tube 3.0 – 750Wh Bosch Akku elegant verpackt im Unterrohr.

Wheel Split – Front 29 Inch Tire and Rear 650B+.

Trail hardtail with 140 mm travel and a flatter steering head angle.

Shadow Edge Tube 3.0 for an elegant integration of the 750Wh Bosch battery.

## XVERT

**SE**  
3.0  
**750**  
Wh  
**85**  
Nm



- Bosch Performance CX Cruise BES3 (25 km/h)
- Bosch Power Tube 750Wh
- Bosch Kiox 300
- E-Power X Vert Boost Gent
- SR Suntour Auton 35 Boost 29" 130mm
- Sram GX Eagle 12S
- Sram GX Eagle 12S
- Magura MT Thirty 203mm I Front
- Magura MT Thirty 180mm I Rear
- Sram X-Sync 34T
- Sram PG1210 Eagle 11-50T 12S
- Sram SX Eagle 12S
- ZZYZX X Vert 29" I Front
- ZZYZX X Vert 650B I Rear
- Schwalbe Nobby Nic 62-622 I Front
- Schwalbe Nobby Nic 70-584 I Rear
- Selle Italia X3 XP BOOST Superflow
- Kindshock Westy Rem 30.9mm
- ZZYZX SL Alloy Stem
- ZZYZX SL Alloy Handlebar

The Rendering is for Reference only

FARBE COLOR

Copper | Pearlized Black

**BK28400**

44 | 49 | 54 | 57

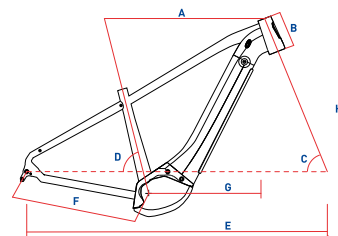

E-POWER X VERT BOOST GENT | SHADOW EDGE TUBE 3.0

CM	A	B	C	D	E	F	G	H
44	635	145	66	73	1212	455	430	671
49	650	145	66	73	1227	455	445	671
54	666	150	66	73	1244	455	460	676
57	684	160	66	73	1263	455	475	685

FEATURES

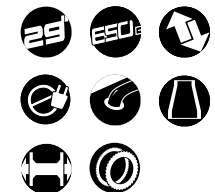



# E-POWER X VERT PRO TEAM

Komfort und Grip dank Wheel Split – vorne 29 Zoll Reifen und hinten 650B+.

Trail Hardtail mit 120mm Federweg und einem flacheren Lenkwinkel.

Shadow Edge Tube 3.0 – 750Wh Bosch Akku elegant verpackt im Unterrohr.

Wheel Split – Front 29 Inch Tire and Rear 650B+.

Trail hardtail with 120 mm travel and a flatter steering head angle.

Shadow Edge Tube 3.0 for an elegant integration of the 750Wh Bosch battery.

**XVERT**

**SE**  
3.0  
**750**  
Wh  
**85**  
Nm



- Bosch Performance CX Cruise BES3 (25 km/h)
- Bosch Power Tube 750Wh
- Bosch Kiox 300
- E-Power X Vert Boost Gent
- Rockshox Recon Silver 29" 120mm
- Shimano Deore XT SGS 12S
- Shimano SLX 12S
- Shimano MT420 180mm I Front
- Shimano MT410 180mm I Rear
- ZYZX E-Power Crank 34T
- Shimano SLX 10-51T 12S
- KMC X12 12S
- ZYZX X Vert 29" I Front
- ZYZX X Vert 650B I Rear
- Schwalbe Nobby Nic 62-622 I Front
- Schwalbe Nobby Nic 70-584 I Rear
- Selle Italia X3 XP BOOST Superflow
- Kindshock 860i 30.9mm
- ZYZX SL Alloy Stem
- ZYZX SL Alloy Handlebar

The Rendering is for Reference only

FARBE COLOR

Dark Red | Dark Metallic Blue | Metallic

BK28401

44 | 49 | 54 | 57

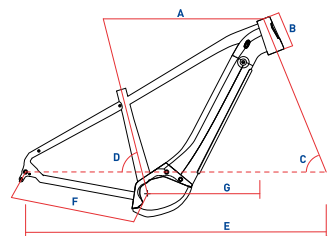

E-POWER X VERT BOOST GENT | SHADOW EDGE TUBE 3.0

CM	A	B	C	D	E	F	G	H
44	635	145	66	73	1212	455	430	671
49	650	145	66	73	1227	455	445	671
54	666	150	66	73	1244	455	460	676
57	684	160	66	73	1263	455	475	685

FEATURES



# E-POWER X VERT PRO TRAPEZ

Komfort und Grip dank Wheel Split – vorne 29 Zoll Reifen und hinten 650B+.

Trail Hardtail mit 120mm Federweg und einem flacheren Lenkwinkel.



















Shadow Edge Tube 3.0 – 750Wh Bosch Akku elegant verpackt im Unterrohr.

Wheel Split – Front 29 Inch Tire and Rear 650B+.

Trail hardtail with 120 mm travel and a flatter steering head angle.

Shadow Edge Tube 3.0 for an elegant integration of the 750Wh Bosch battery.

**XVERT****SE**  
3.0  
**750**  
Wh  
**85**  
Nm

-  Bosch Performance CX Cruise BES3 (25 km/h)
-  Bosch Power Tube 750Wh
-  Bosch Kiox 300
-  E-Power X Vert Boost Trapez
-  SR Suntour XCR32-Boost-AIR LOR DS 29" 120mm
-  Shimano Deore XT 11S
-  Shimano SLX 11S
-  Shimano MT420 180mm I Front
-  Shimano MT410 180mm I Rear
-  ZYZX E-Power Crank 34T
-  Shimano SLX 11-46T 11S
-  KMC X11 11S
-  ZYZX Cross Attack 29" I Front
-  ZYZX Cross Attack 650B I Rear
-  Schwalbe Smart Sam 57-622 I Front
-  Schwalbe Smart Sam 70-584 I Rear
-  corratec sport saddle
-  ZYZX Suspension Seatpost 30.9mm
-  ZYZX SL Alloy Stem
-  ZYZX SL Alloy Handlebar

The Rendering is for Reference only

**FARBE COLOR**

Sand Metallic | Dark Metallic Blue | Red

**BK28402**

👤 39 | 44 | 49 | 54

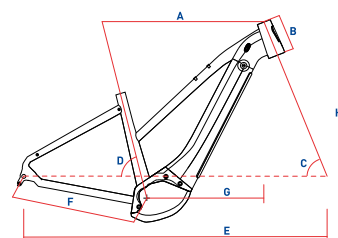
**E-POWER X VERT BOOST TRAPEZ | SHADOW EDGE TUBE 3.0****FEATURES**

CM	A	B	C	D	E	F	G	H
39	616	150	66	73	1194	455	410	676
44	631	160	66	73	1209	455	425	676
49	649	160	66	73	1228	455	440	685
54	667	170	66	73	1247	455	455	694

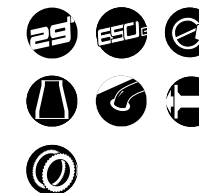



# E-POWER X VERT PRO GENT

Komfort und Grip dank Wheel Split – vorne 29 Zoll Reifen und hinten 650B+.

120mm Federweg für viel Fahrspaß und Sicherheit auf schnellen Abfahrten mit losem Untergrund.

Shadow Edge Tube 3.0 – 750Wh Bosch Akku elegant verpackt im Unterrohr.

Wheel Split – Front 29 Inch Tire and Rear 650B+.

120mm travel ensures riding pleasure and safety on high speed descents.

Shadow Edge Tube 3.0 for an elegant integration of the 750Wh Bosch battery.

**XVERT**

**SE**  
3.0  
**750**  
Wh  
**85**  
Nm



- Bosch Performance CX Cruise BES3 (25 km/h)
- Bosch Power Tube 750Wh
- Bosch Kiox 300
- E-Power X Vert Boost Gent
- SR Suntour XCR32-Boost-AIR LOR DS 29" 120mm
- Shimano Deore SGS 11S
- Shimano SLX 11S
- Shimano MT420 180mm I Front
- Shimano MT410 180mm I Rear
- ZYZX E-Power Crank 34T
- Shimano SLX 11-46T 11S
- KMC X11 11S
- ZYZX X Vert 29" I Front
- ZYZX X Vert 650B I Rear
- Schwalbe Smart Sam 57-622 I Front
- Schwalbe Smart Sam 70-584 I Rear
- corratec sport saddle
- ZYZX Suspension Seatpost 30.9mm
- ZYZX SL Alloy Stem
- ZYZX SL Alloy Handlebar

The Rendering is for Reference only

**FARBE COLOR**

Sand Metallic I Dark Metallic Blue I Red

**BK28403**

44 | 49 | 54 | 57

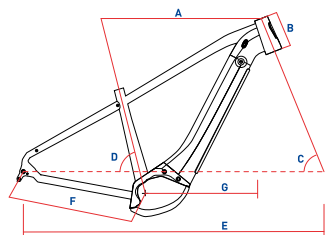

**E-POWER X VERT BOOST GENT I SHADOW EDGE TUBE 3.0**

CM	A	B	C	D	E	F	G	H
44	635	145	66	73	1212	455	430	671
49	650	145	66	73	1227	455	445	671
54	666	150	66	73	1244	455	460	676
57	684	160	66	73	1263	455	475	685

**FEATURES**

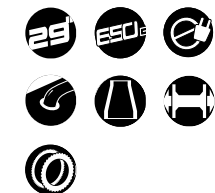

# E-POWER X VERT ELITE TRAPEZ

Komfort und Grip dank Wheel Split – vorne 29 Zoll Reifen und hinten 650B+.



















120mm Federweg für viel Fahrspaß und Sicherheit auf schnellen Abfahrten mit losem Untergrund.

Die Shadow Edge Tube 2.0 Technologie gibt dem Rahmen höchstmögliche Steifigkeit.

Wheel Split – Front 29 Inch Tire and Rear 650B+.

120mm travel for plenty of riding pleasure and safety on technical trails.

Shadow Edge Tube 2.0 – worldwide most stable and safest corratec E-Bike frame with integrated battery.

-  Bosch Performance CX Cruise BES3 (25 km/h)
-  Bosch Power Tube 625Wh
-  Bosch Intuvia 100
-  E-Power X Vert Boost Trapez
-  SR Suntour XCR32-Boost-AIR LOR DS 29" 120mm
-  Shimano Deore SGS 11S
-  Shimano Deore 11S
-  Shimano MT420 180mm I Front
-  Shimano MT410 180mm I Rear
-  ZZYZX E-Power Crank 34T
-  Shimano Deore 11-42T 11S
-  KMC X11 11S
-  ZZYZX X Vert 29" I Front
-  ZZYZX X Vert 650B I Rear
-  Schwalbe Smart Sam 57-622 I Front
-  Schwalbe Smart Sam 70-584 I Rear
-  corratec sport saddle
-  ZZYZX Suspension Seatpost 30.9mm
-  ZZYZX SL Alloy Stem
-  ZZYZX SL Alloy Handlebar



## XVERT

**SE**  
20  
**625**  
Wh  
**85**  
Nm

The Rendering is for Reference only

**FARBE COLOR**  Grey Green | Green | Pearitized Black

**BK28404**

 39 | 44 | 49 | 54

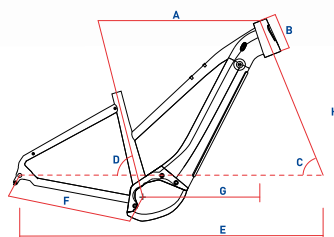

**E-POWER X VERT BOOST TRAPEZ | SHADOW EDGE TUBE 2.0 FEATURES**

CM	A	B	C	D	E	F	G	H
39	616	150	66	73	1194	455	410	676
44	631	160	66	73	1209	455	425	676
49	649	160	66	73	1228	455	440	685
54	667	170	66	73	1247	455	455	694

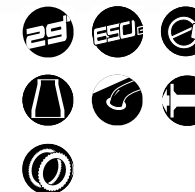



# E-POWER X VERT ELITE GENT

Komfort und Grip dank Wheel Split – vorne 29 Zoll Reifen und hinten 650B+.

120mm Federweg für viel Fahrspaß und Sicherheit auf schnellen Abfahrten mit losem Untergrund.

Die Shadow Edge Tube 2.0 Technologie gibt dem Rahmen höchstmögliche Steifigkeit.

Wheel Split – Front 29 Inch Tire and Rear 650B+.

120mm travel for plenty of riding pleasure and safety on technical trails.

Shadow Edge Tube 2.0 – worldwide most stable and safest corratec E-Bike frame with integrated battery.

**XVERT**

**SE**  
20  
**625**  
Wh  
**85**  
Nm



- Bosch Performance CX Cruise BES3 (25 km/h)
- Bosch Power Tube 625Wh
- Bosch Intuvia 100
- E-Power X Vert Boost Gent
- SR Suntour XCR32-Boost-AIR LOR DS 29" 120mm
- Shimano Deore SGS 11S
- Shimano Deore 11S
- Shimano MT420 180mm I Front
- Shimano MT410 180mm I Rear
- ZYZX E-Power Crank 34T
- Shimano Deore 11-42T 11S
- KMC X11 11S
- ZYZX X Vert 29" I Front
- ZYZX X Vert 650B I Rear
- Schwalbe Smart Sam 57-622 I Front
- Schwalbe Smart Sam 70-584 I Rear
- corratec sport saddle
- ZYZX Suspension Seatpost 30.9mm
- ZYZX SL Alloy Stem
- ZYZX SL Alloy Handlebar

The Rendering is for Reference only

**FARBE COLOR** Grey Green | Green | Pearlized Black

**BK28405**

44 | 49 | 54 | 57

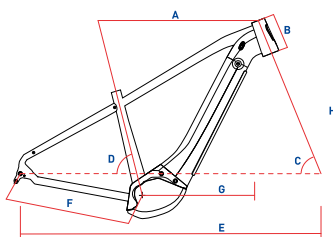

**E-POWER X VERT BOOST GENT I SHADOW EDGE TUBE 2.0**

CM	A	B	C	D	E	F	G	H
44	635	145	66	73	1212	455	430	671
49	650	145	66	73	1227	455	445	671
54	666	150	66	73	1244	455	460	676
57	684	160	66	73	1263	455	475	685

**FEATURES**

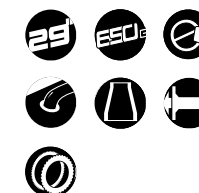

# E-POWER X VERT RACE TRAPEZ

Komfort und Grip dank Wheel Split – vorne 29 Zoll Reifen und hinten 650B+.

120mm Federweg für viel Fahrspaß und Sicherheit auf schnellen Abfahrten mit losem Untergrund.

Die Shadow Edge Tube 2.0 Technologie gibt dem Rahmen höchstmögliche Steifigkeit.

Wheel Split – Front 29 Inch Tire and Rear 650B+.

120mm travel for plenty of riding pleasure and safety on technical trails.

Shadow Edge Tube 2.0 – worldwide most stable and safest corratec E-Bike frame with integrated battery.

-  Bosch Performance CX Cruise BES3 (25 km/h)
-  Bosch Power Tube 625Wh
-  Bosch Intuvia 100
-  E-Power X Vert Boost Trapez
-  SR Suntour XCR32-Boost-AIR LOR DS 29" 120mm
-  Sram SX Eagle 12S
-  Sram SX Eagle 12S
-  Tektro HD-M275 180mm I Front
-  Tektro HD-M275 180mm I Rear
-  Sram X-Sync 34T
-  Sram PG1210 Eagle 11-50T 12S
-  Sram SX Eagle 12S
-  ZZYZX X Vert 29" I Front
-  ZZYZX X Vert 650B I Rear
-  Schwalbe Smart Sam 57-622 I Front
-  Schwalbe Smart Sam 70-584 I Rear
-  corratec sport saddle
-  ZZYZX Suspension Seatpost 30.9mm
-  ZZYZX SL Alloy Stem
-  ZZYZX SL Alloy Handlebar



## XVERT

**SE**  
20  
**625**  
Wh  
**85**  
Nm

The Rendering is for Reference only

FARBE COLOR

 Blue | Mango | Rainbow

**BK28406**

 39 | 44 | 49 | 54

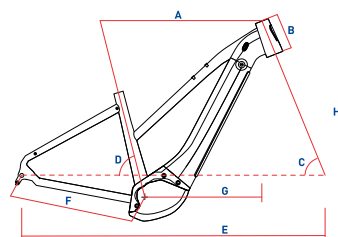

**E-POWER X VERT BOOST TRAPEZ**

CM	A	B	C	D	E	F	G	H
39	616	150	66	73	1194	455	410	676
44	631	160	66	73	1209	455	425	676
49	649	160	66	73	1228	455	440	685
54	667	170	66	73	1247	455	455	694

FEATURES

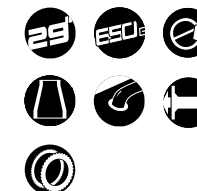



# E-POWER X VERT RACE GENT

Komfort und Grip dank Wheel Split – vorne 29 Zoll Reifen und hinten 650B+.

120mm Federweg für viel Fahrspaß und Sicherheit auf schnellen Abfahrten mit losem Untergrund.

Die Shadow Edge Tube 2.0 Technologie gibt dem Rahmen höchstmögliche Steifigkeit.

Wheel Split – Front 29 Inch Tire and Rear 650B+.

120mm travel for plenty of riding pleasure and safety on technical trails.

Shadow Edge Tube 2.0 – worldwide most stable and safest corratec E-Bike frame with integrated battery.

**XVERT**

**SE**  
20  
**625**  
Wh  
**85**  
Nm



- Bosch Performance CX Cruise BES3 (25 km/h)
- Bosch Power Tube 625Wh
- Bosch Intuvia 100
- E-Power X Vert Boost Gent
- SR Suntour XCR32-Boost-AIR LOR DS 29" 120mm
- Sram SX Eagle 12S
- Sram SX Eagle 12S
- Tektro HD-M275 180mm I Front
- Tektro HD-M275 180mm I Rear
- Sram X-Sync 34T
- Sram PG1210 Eagle 11-50T 12S
- Sram SX Eagle 12S
- ZYZX X Vert 29" I Front
- ZYZX X Vert 650B I Rear
- Schwalbe Smart Sam 57-622 I Front
- Schwalbe Smart Sam 70-584 I Rear
- corratec sport saddle
- ZYZX Suspension Seatpost 30.9mm
- ZYZX SL Alloy Stem
- ZYZX SL Alloy Handlebar

The Rendering is for Reference only

FARBE COLOR

Blue | Mango | Rainbow

**BK28407**

44 | 49 | 54 | 57 |

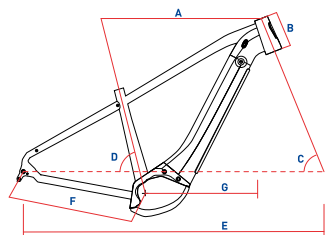

**E-POWER X VERT BOOST GENT**

CM	A	B	C	D	E	F	G	H
44	635	145	66	73	1212	455	430	671
49	650	145	66	73	1227	455	445	671
54	666	150	66	73	1244	455	460	676
57	684	160	66	73	1263	455	475	685

**FEATURES**

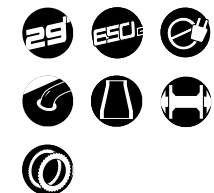

# E-POWER X VERT ROCK 26

## XVERT

Mit seinen 26 Zoll Reifen und einer kompakten Rahmengeometrie eignet sich das X Vert perfekt für Rookies und den E-MTB Nachwuchs.

Die hier verbaute Bosch Antriebseinheit unterstützt den Fahrer bei langen Touren mit der Familie.

The X Vert Young series a 26 inch e-bike for the rookies and MTB stars of tomorrow.

Bosch drive system for day trips with the whole family.

Individually designed and developed Bosch engine cover.



- Bosch Active Line Plus (25km/h)
- Bosch Power Pack 400 Frame
- Bosch Purion
- E-Power X Vert Rock
- SR Suntour XCR-AIR LOR DS 26" 100 mm
- Shimano Altus SGS 9S
- Shimano Altus 9S
- Tektro HDM-282 160mm I Front
- Tektro HDM-282 160mm I Rear
- ZZYZX E-Power Crank 34T
- Shimano HG200 11-36T 9S
- KMC X9 9S
- ZZYZX X Vert 26" I Front
- ZZYZX X Vert 26" I Rear
- Innova Podium 26" x 2.25 I Front
- Innova Podium 26" x 2.25 I Rear
- corratec sport saddle
- ZZYZX Suspension Seatpost 30.9mm
- ZZYZX SL Alloy Stem
- ZZYZX SL Alloy Handlebar

The Rendering is for Reference only

FARBE COLOR

Dark Blue | Orange | Silver

**BK28408**

uni

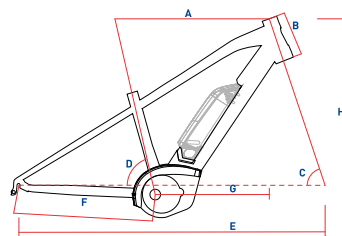

**E-POWER X VERT ROCK**

CM	A	B	C	D	E	F	G	H
39	545	130	67	74	1091	451	374	596

FEATURES











# THE MOUNTAIN CROSS E-BIKE

Mountain Cross Bikes, auch als „MTC“ bezeichnet, nehmen bei corratec einen immer höheren Stellenwert ein, da sie in jedem Gelände perfekt eingesetzt werden können. Die verbaute Shadow Edge 3.0 Technologie in Verbindung mit dem integrierten Akku sorgen für eine formschöne Optik und verleiht dem Rad die höchstmögliche Steifigkeit. Hochwertige Komponenten wie der Direct Mount Gepäckträger mit integriertem Rücklicht unterstützen den Fahrer bei langen Mehrtagestouren.

„MTC“ stands for “Mountain Cross Bike”, the right bike for every terrain. This includes the carrier with the stylish integrated tail light. For a stable and secure frame with integrated rechargeable battery the “Shadow Edge Tube 3.0” technology is used. In addition, the bike is equipped with noble parts of Shimano, SR Suntour, Schwalbe and Selle Italia.

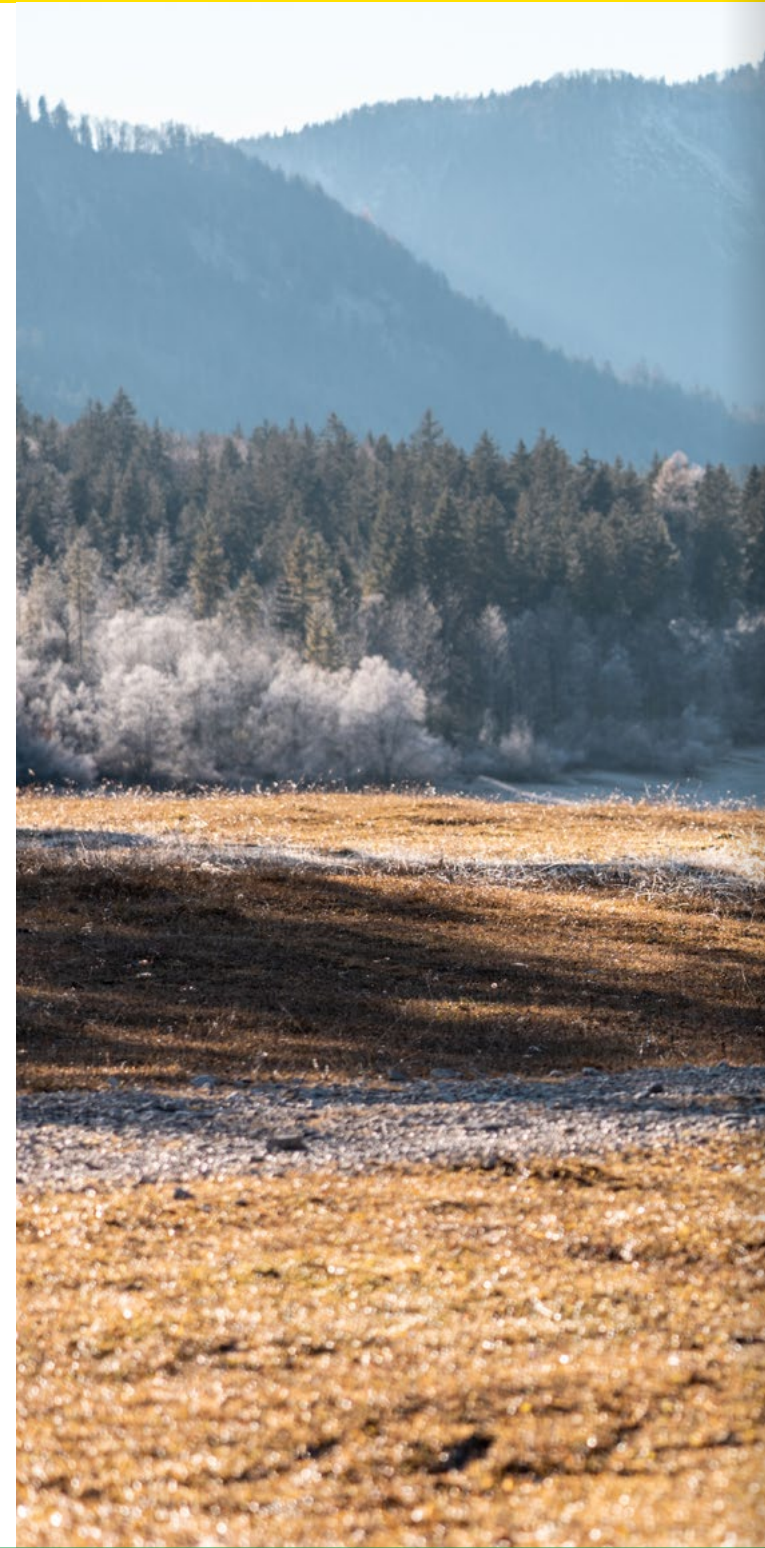





Fuß- und  
Radweg





**TOP**  
E-BIKE DESIGN  
KATEGORIE: SUV/CROSS

**2022**

[www.focus-ebike.de](http://www.focus-ebike.de)

Sechs weitere Modelle erhielten  
diese Auszeichnung

# E-POWER MTC 120



# 3.0

SHADOW  
EDGE TUBE

# 120

mm

Rockshox Lyrik Federweg  
Rockshox Lyrik travel

# ICR

Komplett innenverlegte  
Kabelführung  
Entire Internal Cable Routing





## MAXIMALE SICHERHEIT MAXIMUM SAFETY

Das neuentwickelte Shadow Edge Tube 3.0 - Der weltweit stabilste und sicherste corrated E-Bike Rahmen geht in die nächste Runde. Ein einzigartiges neues Wabendesign sorgt für eine erstklassige Optik.

The newly developed Shadow Edge Tube 3.0 - the world's most stable and safest corrated e-bike frame goes into the next round. An unique new honeycomb design ensures a first-class look.

## MOUNTAINCROSS BIKE

Vollausgestattetes Fully für jeden Einsatzbereich & unterschiedliches Gelände.  
Maximale Traktion und Dämpfung auf langen Trekkingtouren.

Fully equipped for every application and different terrain. Maximum traction and cushioning on long trekking tours.



## ABSOLUT BELASTBAR ABSOLUTELY RESILIENT

Direct Mount Gepäckträger ohne zusätzliche Streben bis 25Kg belastbar. Das voll integrierte Rücklicht sorgt für eine cleane Optik. Extrem stabil, sicher und schön zugleich.

Direct mount luggage rack can be loaded up to 25kg. The fully integrated rear light ensures a clean look. Extreme stable, safe and beautiful at the same time.

# E-POWER MTC 120 PRO

# MTC 120

# SE<sup>3.0</sup>

# 750<sup>Wh</sup>

# 85<sup>Nm</sup>

Das Mountain Cross Bike (MTC) – Für jedes Gelände das perfekte Bike.

Direct Mount Gepäckträger bis 25kg belastbar mit integriertem Rücklicht.

Shadow Edge Tube 3.0 – 750Wh Bosch Akku elegant verpackt im Unterrohr.

The brandnew Mountain Cross Bike (MTC) – The perfect bike for every terrain.

Rear light integrated in the luggage rack – Smart integration for a clean look.

Shadow Edge Tube 3.0 – worldwide most stable and safest corrated E-Bike Frame.



- Bosch Performance CX Cruise BES3 (25 km/h)
- Bosch Power Tube 750Wh
- Bosch Kiox 300
- E-Power MTC 120
- SR Suntour RAIDON34-Boost RLR DS 29" 120mm
- SR Suntour EDGE LOR 190 x 45 mm Air
- L-TWOO A12-X 12S
- L-TWOO A12-X 12S
- Shimano MT420 180mm I Front
- Shimano MT410 180mm I Rear
- ZZYZX E-Power Crank 34T
- L-TWOO A12 11-50T 12S
- KMC X12
- ZZYZX Cross Attack 29" I Front
- ZZYZX Cross Attack 29" I Rear
- Schwalbe Johnny Watts 65-622 I Front
- Schwalbe Johnny Watts 65-622 I Rear
- corrated sport saddle
- ZZYZX SP Alloy Seatpost 31.6mm
- ZZYZX SL Alloy Stem
- ZZYZX SL Alloy Handlebar

The Rendering is for Reference only

FARBE COLOR



Sand Metallic | Dark red | Cool Grey

**BK28430**

39 | 44 | 49 | 54 |

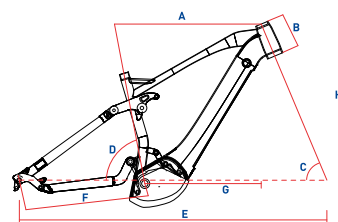

**E-POWER MTC 120 | SHADOW EDGE TUBE 3.0**

CM	A	B	C	D	E	F	G	H
39	612	155	67	74	1212	468	430	637
44	632	155	67	74	1232	468	450	637
49	654	160	67	74	1254	468	470	642
54	676	170	67	74	1278	468	490	651

FEATURES





# E-POWER MTC 120 ELITE

**MTC  
120**

**SE<sup>3.0</sup>  
750  
Wh  
85  
Nm**

E-BIKE

Das Mountain Cross Bike (MTC) – Für jedes Gelände das perfekte Bike.

Direct Mount Gepäckträger bis 25kg belastbar mit integriertem Rücklicht.

Shadow Edge Tube 3.0 – weltweit stabilster und sicherster corratec E-Bike Rahmen.

The brandnew Mountain Cross Bike (MTC) – The perfect bike for every terrain.

Rear light integrated in the luggage rack – Smart integration for a clean look.

Shadow Edge Tube 3.0 – worldwide most stable and safest corratec E-Bike Frame.



- Bosch Performance CX Cruise BES3 (25 km/h)
- Bosch Power Tube 750Wh
- Bosch Kiox 300
- E-Power MTC 120
- SR Suntour XCR32-Boost-AIR LOR DS 29" 120mm
- SR Suntour EDGE R 190 x 45 mm Air
- Sram SX Eagle 12S
- Sram SX Eagle 12S
- Tektro HD-M275 180mm | Front
- Tektro HD-M275 180mm | Rear
- Sram X-Sync 34T
- Sram PG1210 Eagle 11-50T 12S
- Sram SX Eagle 12S
- ZYZX Cross Attack 29" | Front
- ZYZX Cross Attack 29" | Rear
- Schwalbe Johnny Watts 60-622 | Front
- Schwalbe Johnny Watts 60-622 | Rear
- corratec sport saddle
- ZYZX SP Alloy Seatpost 30.9mm
- ZYZX SL Alloy Stem
- ZYZX SL Alloy Handlebar

The Rendering is for Reference only

**FARBE COLOR**

Silver Grey | Tactic Green | Cosmos Black

**BK28431**

39 | 44 | 49 | 54

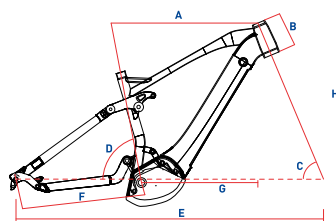

**E-POWER MTC 120 | SHADOW EDGE TUBE 3.0**

CM	A	B	C	D	E	F	G	H
39	612	155	67	74	1212	468	430	637
44	632	155	67	74	1232	468	450	637
49	654	160	67	74	1254	468	470	642
54	676	170	67	74	1278	468	490	651

**FEATURES**



# E-POWER MTC 120

Das Mountain Cross Bike (MTC) – Für jedes Gelände das perfekte Bike.





















Im Gepäckträger integriertes Rücklicht für eine saubere Optik.

Shadow Edge Tube 2.0 – weltweit stabilster und sicherster corratec E-Bike Rahmen.

The brandnew Mountain Cross Bike (MTC) – The perfect bike for every terrain.

Rear light integrated in the luggage rack – Smart integration for a clean look.

Shadow Edge Tube 2.0 – worldwide most stable and safest corratec E-Bike Frame

-  Bosch Performance CX Cruise BES3 (25 km/h)
-  Bosch Power Tube 625Wh
-  Bosch Intuvia 100
-  E-Power MTC 120
-  SR Suntour XCR32-Boost-AIR LOR DS 29" 120 mm
-  SR Suntour EDGE R 190 x 45 mm Air
-  Sram SX Eagle 12S
-  Sram SX Eagle 12S
-  Tektro HDM-275 180mm I Front
-  Tektro HDM-275 180mm I Rear
-  Sram X-Sync 34T
-  Sram PG1210 Eagle 11-50T 12S
-  Sram SX Eagle 12S
-  ZZYZX Cross Attack 29" I Front
-  ZZYZX Cross Attack 29" I Rear
-  Schwalbe Johnny Watts 60-622 I Front
-  Schwalbe Johnny Watts 60-622 I Rear
-  corratec sport saddle
-  ZZYZX SP Alloy Seatpost 30.9mm
-  ZZYZX SL Alloy Stem
-  ZZYZX SL Alloy Handlebar



## MTC 120

### SE<sup>20</sup>

### 625<sup>Wh</sup>

### 85<sup>Nm</sup>

The Rendering is for Reference only

**FARBE COLOR**



Gray Green | Pearlized Black | Silver

**BK28432**

39 | 44 | 49 | 54 |

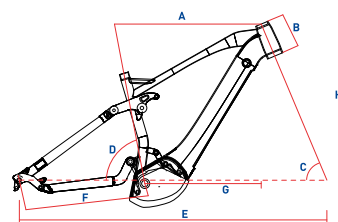

**E-POWER MTC 120 | SHADOW EDGE TUBE 2.0**

CM	A	B	C	D	E	F	G	H
39	612	155	67	74	1212	468	430	637
44	632	155	67	74	1232	468	450	637
49	654	160	67	74	1254	468	470	642
54	676	170	67	74	1278	468	490	651

**FEATURES**





# E-POWER MTC 100 WAVE

**MTC**  
**100**

**SE**  
3.0  
**750**  
Wh  
**85**  
Nm

E-BIKE

Das ideale E-Bike als SUV Fully mit besten Dämpfungseigenschaften für jedes Gelände.

Der tiefe Einstieg bietet dem Fahrer zu jedem Zeitpunkt maximale Sicherheit und Kontrolle.

Hochwertige Komponenten wie der Direct Mount Gepäckträger mit integriertem Rücklicht.

The ideal e-bike as an SUV fully with the best damping properties for any terrain.

The low entry offers the rider maximum safety and control at all times.

High quality components such as the direct mount luggage rack with integrated rear light.



- Bosch Performance CX Cruise BES3 (25 km/h)
- Bosch Power Tube 750Wh
- Bosch Kiox 300
- E-Power MTC 100 Wave
- XCR32-Boost-AIR LOR DS 27.5" 100 mm
- EDGE R 170 x 35 mm Air
- L-TW00 A12-X 12S
- L-TW00 A12-X 12S
- Tektro HDM-275 180mm I Front
- Tektro HDM-275 180mm I Rear
- ZZYZX E-Power Crank 34T
- L-TW00 A12 11-50T 12S
- Sram SX Eagle 12S
- ZZYZX MTC Cross 650B I Front
- ZZYZX MTC Cross 650B I Rear
- Schwalbe Johnny Watts 60-584 I Front
- Schwalbe Johnny Watts 60-584 I Rear
- corratec sport saddle
- Kindschock 900i
- ZZYZX TDS-C634 Stem
- ZZYZX SL Alloy Handlebar

The Rendering is for Reference only

**FARBE COLOR**

Grey Blue | Gold | Pearlized Black

Dark Red | Metallic Brick Red | Cosmos Black

**BK28433**

**S | M | L**

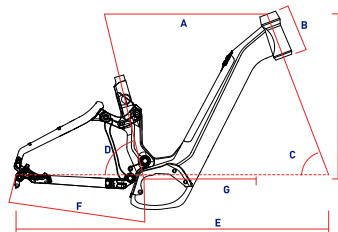

**E-POWER MTC 100 WAVE**

CM	A	B	C	D	E	F	G	H
<b>S</b>	623	150	67	74	1223	485	446	617
<b>M</b>	636	170	69	74	1193	490	451	646
<b>L</b>	650	190	69	74	1210	490	460	664

**FEATURES**



# E-POWER MTC ELITE 12S SE 3.0 TRAPEZ

Das Mountain Cross Bike (MTC) – Für jedes Gelände das perfekte Bike.



















Direct Mount Gepäckträger bis 25kg belastbar mit integriertem Rücklicht.

Shadow Edge Tube 3.0 – 750Wh Bosch Akku elegant verpackt im Unterrohr.

The brandnew Mountain Cross Bike (MTC) – The perfect bike for every terrain.

Rear light integrated in the luggage rack – Smart integration for a clean look.

Shadow Edge Tube 3.0 – worldwide most stable and safest corratedec E-Bike Frame.

-  Bosch Performance CX Cruise BES3 (25 km/h)
-  Bosch Power Tube 750Wh
-  Bosch Intuvia 100
-  E-Power MTC Trapez
-  SR Suntour XCM LO DS 29" 80mm
-  Sram SX Eagle 12S
-  Sram SX Eagle 12S
-  Tektro HD-T275 180mm I Front
-  Tektro HD-T275 160mm I Rear
-  Sram X-Sync 38T
-  Sram PG1210 Eagle 11-50T 12S
-  Sram SX Eagle 12S
-  ZZYZX MTC Cross 29" I Front
-  ZZYZX MTC Cross 29" I Rear
-  Schwalbe Smart Sam 57-622 I Front
-  Schwalbe Smart Sam 57-622 I Rear
-  corratedec sport saddle
-  ZZYZX Suspension Seatpost 30.9mm
-  ZZYZX SL Alloy Stem
-  ZZYZX SL Alloy Handlebar



**SE**  
3.0  
**750**  
Wh  
**85**  
Nm

The Rendering is for Reference only

FARBE COLOR

 Metallic Brown | Pearlized Black | Orange

**BK28440**

 39 | 44 | 49 | 54 |

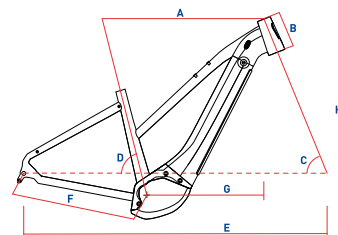

E-POWER MTC TRAPEZ | SHADOW EDGE TUBE 3.0

CM	A	B	C	D	E	F	G	H
39	630	170	68	74	1192	460	440	664
44	638	170	68	74	1200	460	448	664
49	649	180	68	74	1212	460	456	673
54	647	190	68	74	1224	460	464	682

FEATURES





# E-POWER MTC ELITE 12S SE 3.0 GENT

SE  
3.0  
750  
Wh  
85  
Nm

Das Mountain Cross Bike (MTC) – Für jedes Gelände das perfekte Bike.

Direct Mount Gepäckträger bis 25kg belastbar mit integriertem Rücklicht.

Shadow Edge Tube 3.0 – weltweit stabilster und sicherster corratec E-Bike Rahmen.

The brandnew Mountain Cross Bike (MTC) – The perfect bike for every terrain.

Rear light integrated in the luggage rack – Smart integration for a clean look.

Shadow Edge Tube 3.0 – worldwide most stable and safest corratec E-Bike Frame.



- Bosch Performance CX Cruise BES3 (25 km/h)
- Bosch Power Tube 750Wh
- Bosch Intuvia 100
- E-Power MTC Gent
- SR Suntour XCM LO DS 29" 80mm
- Sram SX Eagle 12S
- Sram SX Eagle 12S
- Tektro HD-T275 180mm I Front
- Tektro HD-T275 160mm I Rear
- Sram X-Sync 38T
- Sram PG1210 Eagle 11-50T 12S
- Sram SX Eagle 12S
- ZZYZX MTC Cross 29" I Front
- ZZYZX MTC Cross 29" I Rear
- Schwalbe Smart Sam 57-622 I Front
- Schwalbe Smart Sam 57-622 I Rear
- corratec sport saddle
- ZZYZX Suspension Seatpost 30.9mm
- ZZYZX SL Alloy Stem
- ZZYZX SL Alloy Handlebar

The Rendering is for Reference only

FARBE COLOR

Metallic Brown | Pearlized Black | Orange

BK28441

44 | 49 | 54 | 57

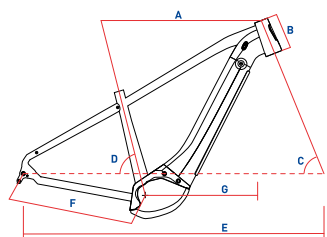

E-POWER MTC GENT | SHADOW EDGE TUBE 3.0

CM	A	B	C	D	E	F	G	H
44	635	165	68	74	1197	460	446	659
49	643	165	68	74	1205	460	454	659
54	653	170	68	74	1212	460	462	664
57	651	180	68	75	1226	460	470	673

FEATURES



# E-POWER MTC 12S TRAPEZ

**MTC**

Das Mountain Cross Bike (MTC) – Für jedes Gelände das perfekte Bike.

Direct Mount Gepäckträger bis 25kg belastbar mit integriertem Rücklicht.

Shadow Edge Tube 2.0 – 625Wh Bosch Akku elegant verpackt im Unterrohr.

The brandnew Mountain Cross Bike (MTC) – The perfect bike for every terrain.

Rear light integrated in the luggage rack – Smart integration for a clean look.

Shadow Edge Tube 2.0 – worldwide most stable and safest corratedec E-Bike Frame.

**SE**  
20  
**625**  
Wh  
**85**  
Nm



- Bosch Performance CX Cruise BES3 (25 km/h)
- Bosch Power Tube 625Wh
- Bosch Intuvia 100
- E-Power MTC Trapez
- SR Suntour XCM LO DS 29" 80mm
- Sram SX Eagle 12S
- Sram SX Eagle 12S
- Tektro HD-T275 180mm | Front
- Tektro HD-T275 160mm | Rear
- Sram X-Sync 38T
- Sram PG1210 Eagle 11-50T 12S
- Sram SX Eagle 12S
- ZZYZX MTC Cross 29" | Front
- ZZYZX MTC Cross 29" | Rear
- Schwalbe Smart Sam 57-622 | Front
- Schwalbe Smart Sam 57-622 | Rear
- corratec sport saddle
- ZZYZX Suspension Seatpost 30.9mm
- ZZYZX SL Alloy Stem
- ZZYZX SL Alloy Handlebar

The Rendering is for Reference only

**FARBE COLOR**

Light Grey | Anthracite | Mustard Yellow

**BK28442**

39 | 44 | 49 | 54 |

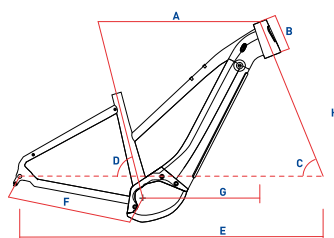

**E-POWER MTC TRAPEZ | SHADOW EDGE TUBE 2.0**

CM	A	B	C	D	E	F	G	H
39	630	170	68	74	1192	460	440	664
44	638	170	68	74	1200	460	448	664
49	649	180	68	74	1212	460	456	673
54	647	190	68	74	1224	460	464	682

**FEATURES**





MTC

# E-POWER MTC 12S GENT

Das Mountain Cross Bike (MTC) – Für jedes Gelände das perfekte Bike.

Direct Mount Gepäckträger bis 25kg belastbar mit integriertem Rücklicht.

Shadow Edge Tube 2.0 – weltweit stabilster und sicherster corratec E-Bike Rahmen.

The brandnew Mountain Cross Bike (MTC) – The perfect bike for every terrain.

Rear light integrated in the luggage rack – Smart integration for a clean look.

Shadow Edge Tube 2.0 – worldwide most stable and safest corratec E-Bike Frame.

SE<sub>20</sub>  
625 Wh  
85 Nm



- Bosch Performance CX Cruise BES3 (25 km/h)
- Bosch Power Tube 625Wh
- Bosch Intuvia 100
- E-Power MTC Gent
- SR Suntour XCM LO DS 29" 80mm
- Sram SX Eagle 12S
- Sram SX Eagle 12S
- Tektro HD-T275 180mm I Front
- Tektro HD-T275 160mm I Rear
- Sram X-Sync 38T
- Sram PG1210 Eagle 11-50T 12S
- Sram SX Eagle 12S
- ZZYZX MTC Cross 29" I Front
- ZZYZX MTC Cross 29" I Rear
- Schwalbe Smart Sam 57-622 I Front
- Schwalbe Smart Sam 57-622 I Rear
- corratec sport saddle
- ZZYZX Suspension Seatpost 30.9mm
- ZZYZX SL Alloy Stem
- ZZYZX SL Alloy Handlebar

The Rendering is for Reference only

FARBE COLOR

Light Grey | Anthracite | Mustard Yellow

BK28443

44 | 49 | 54 | 57 |

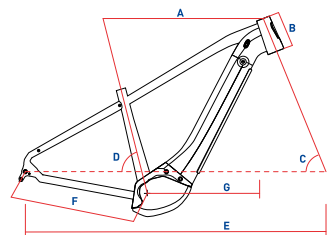

E-POWER MTC GENT | SHADOW EDGE TUBE 2.0

CM	A	B	C	D	E	F	G	H
44	635	165	68	74	1197	460	446	659
49	643	165	68	74	1205	460	454	659
54	653	170	68	74	1212	460	462	664
57	651	180	68	75	1226	460	470	673

FEATURES



# corrateg

## LifeS

Let's go crazy - mit unserem neuen corrateg LifeS sind Dir alle Blicke garantiert! Die extravagante Rahmenform und der moderne Style des urbanen corrateg E-Bikes sind einzigartig am Markt. Mit der Wahl von Farbkombinationen des Rahmens und Schutzblech kannst Du Dir Dein stylisches Rad selbst nach Deinen Wünschen gestalten, um trendig durch die City zu cruisen. Die hervorragende Geometrie des Rahmens und die breiten Reifen garantieren Dir zusätzlich höchste Sicherheit. Beide Füße können jederzeit, auch während der Fahrt, auf dem Boden abgestellt werden.

Discover a different world of corrateg. Cheeky, provocative, hipp, stylish, modern, outstanding, cool, unique - That is what corrateg Life S stands for. Customize the individual mud guards, and you can style your Life S according to your personal lifestyle. The compact Life S is easy to ride through the city and its special geometry enables you to stand with both feet on the ground while sitting on the saddle.









*Life*  
*corratac*





## BREITE REIFEN

### WIDE TIRES

Konzipiert für Kopfsteinpflaster und Straßenbahnschienen.  
Developed for cobblestones and tram tracks.



## TIEFER EINSTIEG

### LOW ENTRY

Komfortabler und tiefer Einstieg um problemlos auf- und abzusteigen.  
Comfortable and low entry to get on and off the bike quickly.



## GEPÄCKTRÄGER

### STURDY CARRIER

Extra großer und stabiler Gepäckträger für die täglichen Einkäufe.  
Extra large and stable carrier system for the daily needs.



## BREITER LENKER

### WIDE HANDLEBAR

Sorgt für zusätzliche Sicherheit und ein ergonomisches Fahrgefühl.  
Provides additional safety and an ergonomic feeling.



## KOMFORT SATTEL

### COMFORT SADDLE

Ermüdungsfreies und komfortables Sitzen.  
Relaxed and comfortable sitting.



## KRAFTVOLLER MOTOR

### POWERFUL ENGINE

Bosch Motor unterstützt bis 25 km/h und entkoppelt vollständig.  
Powerfull Bosch engine supports up to 25 km/h.



## ONE SIZE FITS ALL

### ONE SIZE FITS ALL

Eine Rahmengröße für jede Körpergröße und jeden Typen.  
One frame fits (almost) for every body size.



# CORRATEC LIFE S AP5

One Size Fits All –

Eine Rahmengröße für jeden Fahrertyp.

Individuelle Zusammenstellung  
der Schutzblechfarbkombinationen.

Extra breite Reifen für mehr Fahrsicherheit in der  
Stadt.

One Size Fits All –

One frame size for every type of rider.

Customized mud guards combination  
for an individual design.

Extra wide tires for superior safety  
and comfort in the city.

-  Bosch Active Line Plus (25km/h)
-  Bosch Power Pack 500Wh Frame
-  Bosch Purion
-  corratec Life S
-  Life S Alloy Fork Boost
-  Shimano Nexus 8S
-  Shimano Nexus Revo Shifter 8S
-  Shimano MT200 180mm I Front
-  Shimano MT200 160mm I Rear
-  ZYZX E-Power Crank 38T
-  Shimano 16T
-  KMC Z1 8S
-  ZYZX 20" I Front
-  ZYZX 20" I Rear
-  Inova 20" x 3.0 I Front
-  Inova 20" x 3.0 I Rear
-  corratec comfort saddle
-  ZYZX Suspension Seatpost 30.9mm
-  Ergotec Cobra Tube Level 2
-  Ergotec Bügel EWG



The Rendering is for Reference only

FARBE COLOR



BK28361

 Uni

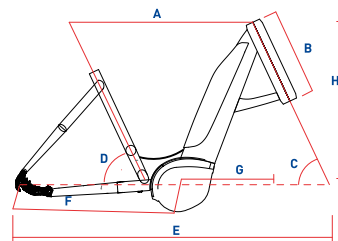

CORRATEC LIFE S

CM	A	B	C	D	E	F	G	H
uni	626	300	65	63	1129	541	259	568

FEATURES





# CORRATEC LIFE S CROSS P6

One Size Fits All –  
Eine Rahmengröße für jeden Fahrertyp.

Individuelle Zusammenstellung  
der Schutzblechfarbkombinationen.

Extra breite Reifen für mehr Fahrsicherheit in der  
Stadt.

One Size Fits All –  
One frame size for every type of rider.

Customized mud guards combination  
for an individual design.

Extra wide tires for superior safety  
and comfort in the city.

-  Bosch Performance Line GEN3 60
-  Bosch Power Pack 500 Frame
-  Bosch Intuvia 100
-  corratec Life S
-  Life S Alloy Fork Boost
-  Shimano Altus SGS 9S
-  Shimano Altus 9S
-  Shimano MT200 180mm I Front
-  Shimano MT200 160mm I Rear
-  ZZYZX E-Power Crank 38T
-  Shimano HG200 11-36T 9S
-  KMC X9 9S
-  ZZYZX 20" I Front
-  ZZYZX 20" I Rear
-  Kenda Crosser 20" x 4.0 I Front
-  Kenda Crosser 20" x 4.0 I Rear
-  corratec comfort saddle
-  ZZYZX Suspension Seatpost 30.9mm
-  Ergotec Cobra Tube Level 2
-  Ergotec Bügel EWG



The Rendering is for Reference only

FARBE COLOR 

**BK28363**

 Uni

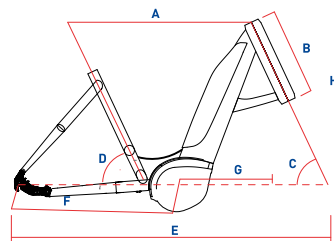

**CORRATEC LIFE S**

CM	A	B	C	D	E	F	G	H
uni	626	300	65	63	1129	541	259	568

**FEATURES**



# *corrateg*

## LIFE

Das corrateg Life klassifiziert sich als SUV unter den E-Bikes. Durch die extrem stabile Bauweise mit dem Shadow Edge Tube 3.0 als weltweit sicherster corrateg E-Bike Rahmen, ist das Bike ideal für lange Touren. Eine Belastung bis 180kg Systemgewicht ist bei diesem Modell möglich. Der tiefe Einstieg und die ergonomischen Komponenten garantieren ein sehr angenehmes Gefühl beim Fahren auf Asphalt und auf Schotterpisten.

The corrateg Life is classified as an SUV among the E-Bikes. Due to the worldwide most stable and safest corrateg E-Bike frame, Shadow Edge Tube 3.0, the bike fits perfectly for long tours across stick and stone. A load of up to 180kg system weight is possible with this model. The low entry and the ergonomic components ensures comfort and safety in the same way.

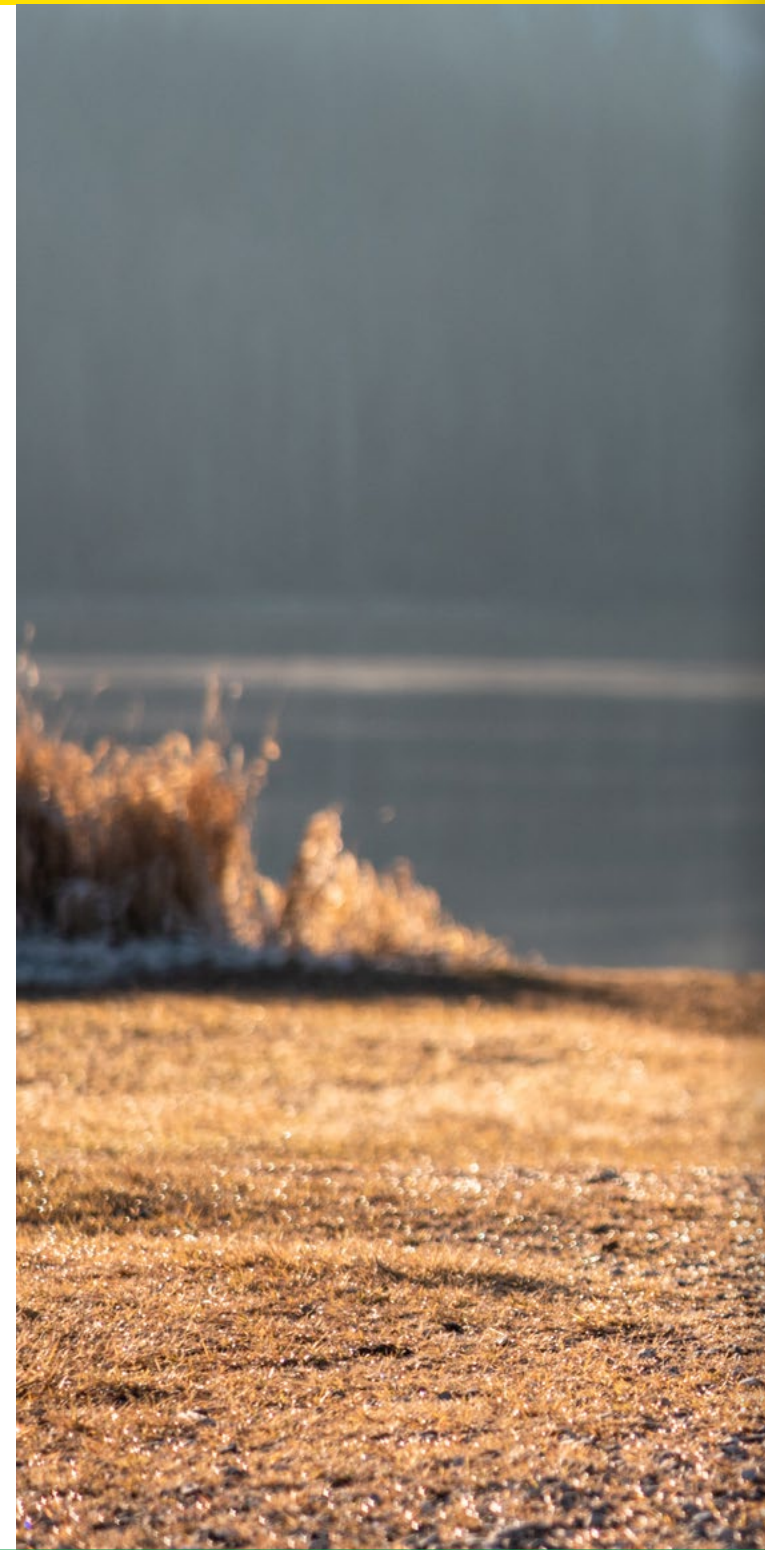









# CORRATEC LIFE

**„DAS BESTE TRAININGSGERÄT  
FÜR EIN GESUNDES LEBEN“**

*„THE BEST TRAINING DEVICE  
FOR A HEALTHY LIFE“*

**DR. MED.  
LUDWIG VINCENT GEIGER**

**BEKANNTER SPORTMEDIZINER UND  
ENTWICKLER DES CORRATEC LIFE.**

WELL KNOWN SPORTS PHYSICIAN AND  
DEVELOPER OF CORRATEC LIFE.



## KUNST DER BEWEGUNG ART OF MOVEMENT

*Für den bekannten Sportmediziner war es eine Herzensangelegenheit, eine prophylaktische sowie kurative Therapie mit dem corrateg Life für seine Patienten zu entwickeln. Denn regelmäßige Bewegung erhöht die körperliche und geistige Leistungsfähigkeit, hilft dabei effizient Stress abzubauen, unterstützt die Erhaltung der Gesundheit, Beweglichkeit, kardiologische Funktionsfähigkeit und sorgt über allem für Lebensfreude. Detaillierte Informationen zu „Kunst der Bewegung“ finden Sie im gleichnamigen Buch.*

*The famous sports physician Ludwig V. Geiger created and introduced a prophylactic and curative therapy with the corrateg life for his patients. Because regular exercises increase physical and mental performance, helps to reduce stress efficiently, supports the maintenance of health, flexibility, cardiac and provides vitality.*

*Detailed information on „Art of Movement“ can be found in his homonymous book.*



### „DIE KUNST DER BEWEGUNG“

Von Dr. Ludwig V. Geiger, Entwickler des  
corrateg Life.

Gebundene Ausgabe, 480 Seiten,

ISBN: 978-3-475-54329-6





**FOCUS**  
**E-BIKE**  
DESIGN AWARD

**TOP**  
E-BIKE DESIGN  
KATEGORIE: TREKKING

**2022**

[www.focus-ebike.de](http://www.focus-ebike.de)

Sechs weitere Modelle erhielten  
diese Auszeichnung

# CORRATEC LIFE

# 180<sup>kg</sup>

Zulässiges Gesamtgewicht  
Overall Systemweight

# 3.0

SHADOW  
EDGE TUBE

# 750<sup>WH</sup>

Sensationelle Reichweite  
Outstanding capacity







## TIEFER EINSTIEG LOW ENTRY

Komfortabler und tiefer Einstieg um schnell und sicher vom Rad auf- und abzusteigen, als ein zusätzliches Sicherheits Feature. Die speziell entwickelte Rahmengeometrie erzielt ausreichend Spielraum bei plötzlichem Absteigen!

Comfortable and deep entry to get quick and safe on and off the bike. An additional safety feature for more secureness in the city traffic jam or on extended bike trips across stick and stone.

## SICHERES BREMSSEN SAFE BRAKING

Um Ihnen noch mehr Sicherheit zu bieten, haben wir die Vorderbremse rot gestaltet. Absteigen über den Lenker oder ein rutschendes Vorderrad gehören der Vergangenheit an.

For more security the front brake is designed in corratec life red. Sliding front wheels and flips across the handlebar are things of the past.



## SHADOW EDGE TUBE 3.0

Der weltweit stabilste und sicherste corratec E-Bike Rahmen geht in die nächste Runde. Mit einem einzigartigen Wabendesign und 750Wh Akku katapultiert das neue Unterrohr unsere corratec E-Bikes auf die nächste Ebene.

The worldwide most stable and safest corratec e-bike frame is entering the next round. With an unique honeycomb design and 750 Wh battery, the new down tube catapults our corratec e-bikes to the next level.

# CORRATEC LIFE CX7 ABS

Extrem stabiler Shadow Edge Tube 3.0 Rahmen mit 180kg zulässigem Systemgewicht.

Maximale Verwindungssteifigkeit mit dem neuen, voll integrierten Powertube 750Wh Akku.











Hochwertige Komponenten sorgen für ein ergonomisches Fahrgefühl.

Outstanding:

Permissible system weight up to 180 Kg.

Shadow Edge Tube 3.0 for an elegant integration of the 750Wh Bosch battery.

The E-Bike SUV – Amazing performance both on and off the road.

-  Bosch Performance CX Cruise BES3 (25 km/h)
-  Bosch Power Tube 750Wh
-  Bosch Kiox 300
-  corrateg Life
-  SR Suntour MOBIE34-AIR LOR DS 100mm
-  Enviolo Trekking
-  Enviolo Manual Controller
-  Magura MT C ABS Allroad 203mm I Front
-  Magura MT C ABS Allroad 180mm I Rear
-  ZZYX E-Power Crank 38T
-  Enviolo 20T
-  KMC Z1
-  ZZYX Life 650B I Front
-  ZZYX Life 650B I Rear
-  Schwalbe Johnny Watts 60-584 I Front
-  Schwalbe Johnny Watts 60-584 I Rear
-  SQ Lab 621 ERGOLUX active
-  ZZYX SP Alloy Seatpost 30.9mm
-  ZZYX SL Alloy Stem ICR
-  ZZYX corrateg Life Handlebar



**SE**  
3.0  
**750**  
Wh  
**85**  
Nm

The Rendering is for Reference only

FARBE COLOR



Silver | Red | Cool Grey



Black | Red White | Cool Grey

**BK28351**

 39 | 42 | 47 | 53 | 57

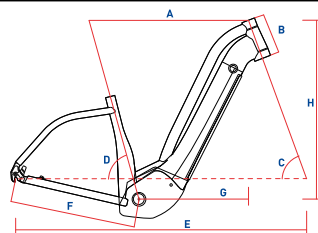

**CORRATEC LIFE | SHADOW EDGE TUBE 3.0**

CM	A	B	C	D	E	F	G	H
39	593	160	68	77	1181	460	443	653
42	601	170	68	77	1190	460	448	663
47	608	180	68	77	1199	460	453	673
53	616	190	69	77	1197	460	458	686
57	623	200	69	77	1205	460	463	696

**FEATURES**





# CORRATEC LIFE CX7

Extrem stabiler Shadow Edge Tube 3.0 Rahmen mit 180kg zulässigem Systemgewicht.

Maximale Verwindungssteifigkeit mit dem neuen, voll integrierten Powertube 750Wh Akku.

Hochwertige Komponenten sorgen für ein ergonomisches Fahrgefühl.

Outstanding:

Permissible system weight up to 180 Kg.

Shadow Edge Tube 3.0 for an elegant integration of the 750Wh Bosch battery.

The E-Bike SUV – Amazing performance both on and off the road.

**SE**  
3.0  
**750**  
Wh  
**85**  
Nm



- Bosch Performance CX Cruise BES3 (25 km/h)
- Bosch Power Tube 750Wh
- Bosch Kiox 300
- corratec Life
- SR Suntour MOBIE25-AIR LOR DS 100mm
- Enviolo Trekking
- Enviolo Manual Controller
- Magura MT Thirty 203mm I Front
- Magura MT Thirty 180mm I Rear
- ZZYX E-Power Crank 38T
- Enviolo 20T
- KMC Z1
- ZZYX Life 650B I Front
- ZZYX Life 650B I Rear
- Schwalbe Johnny Watts 60-584 I Front
- Schwalbe Johnny Watts 60-584 I Rear
- SQ Lab 621 ERGOLUX active
- ZZYX SP Alloy Seatpost 30.9mm
- ZZYX SL Alloy Stem ICR
- ZZYX corratec Life Handlebar

The Rendering is for Reference only

**FARBE COLOR**



Silver | Red | Cool Grey



Black | Red White | Cool Grey

**BK28350**

**39 | 42 | 47 | 53 | 57**

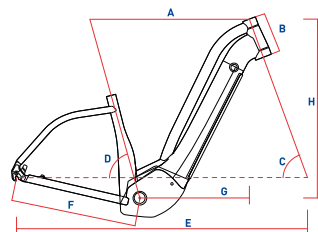

**CORRATEC LIFE | SHADOW EDGE TUBE 3.0**

CM	A	B	C	D	E	F	G	H
<b>39</b>	593	160	68	77	1181	460	443	653
<b>42</b>	601	170	68	77	1190	460	448	663
<b>47</b>	608	180	68	77	1199	460	453	673
<b>53</b>	616	190	69	77	1197	460	458	686
<b>57</b>	623	200	69	77	1205	460	463	696

**FEATURES**





# CORRATEC LIFE CX7 12S ABS

Extrem stabiler Shadow Edge Tube 3.0 Rahmen mit 180kg zulässigem Systemgewicht.

Maximale Verwindungssteifigkeit mit dem neuen, voll integrierten Powertube 750Wh Akku.

Hochwertige Komponenten sorgen für ein ergonomisches Fahrgefühl.

Outstanding:

Permissible system weight up to 180 Kg.

Shadow Edge Tube 3.0 for an elegant integration of the 750Wh Bosch battery.

The E-Bike SUV – Amazing performance both on and off the road.

- Bosch Performance CX Cruise BES3 (25 km/h)
- Bosch Power Tube 750Wh
- Bosch Kiox 300
- corrateg Life
- SR Suntour MOBIE34-AIR LOR DS 100mm
- Sram SX Eagle 12S
- Sram SX Eagle 12S
- Magura MT C ABS Allroad 203mm I Front
- Magura MT C ABS Allroad 203mm I Rear
- Sram X-Sync 38T
- Sram PG1210 Eagle 11-50T 12S
- Sram SX Eagle 12S
- ZZYX Life 650B I Front
- ZZYX Life 650B I Rear
- Schwalbe Johnny Watts 60-584 I Front
- Schwalbe Johnny Watts 60-584 I Rear
- SQ Lab 621 ERGOLUX active
- ZZYX Suspension Seatpost 30.9mm
- ZZYX SL Alloy Stem ICR
- ZZYX corrateg Life Handlebar



**SE**  
3.0  
**750**  
Wh  
**85**  
Nm

The Rendering is for Reference only

FARBE COLOR



Silver | Red | Cool Grey



Black | Red White | Cool Grey

**BK28354**

39 | 42 | 47 | 53 | 57

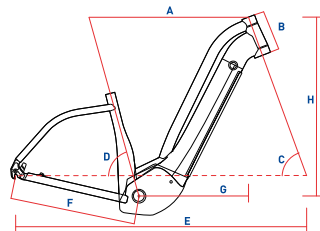

**CORRATEC LIFE | SHADOW EDGE TUBE 3.0**

CM	A	B	C	D	E	F	G	H
39	593	160	68	77	1181	460	443	653
42	601	170	68	77	1190	460	448	663
47	608	180	68	77	1199	460	453	673
53	616	190	69	77	1197	460	458	686
57	623	200	69	77	1205	460	463	696

**FEATURES**





# CORRATEC LIFE CX7 12S

Extrem stabiler Shadow Edge Tube 3.0 Rahmen mit 180kg zulässigem Systemgewicht.

Maximale Verwindungssteifigkeit mit dem form-schönen, voll integrierten Powertube 750Wh.

Hochwertige Komponenten sorgen für ein angenehmes und ergonomisches Fahrgefühl.

Outstanding:

Permissible system weight up to 180 Kg.

Shadow Edge Tube 3.0 for an elegant integration of the 750Wh Bosch battery.

The E-Bike SUV – Amazing performance both on and off the road.

**SE**  
3.0  
**750**  
Wh  
**85**  
Nm



- Bosch Performance CX Cruise BES3 (25 km/h)
- Bosch Power Tube 750Wh
- Bosch Kiox 300
- corratec Life
- SR Suntour MOBIE25-AIR LOR DS 100mm
- Sram SX Eagle 12S
- Sram SX Eagle 12S
- Magura MT Thirty 203mm I Front
- Magura MT Thirty 180mm I Rear
- Sram X-Sync 38T
- Sram PG1210 Eagle 11-50T 12S
- Sram SX Eagle 12S
- ZZYX Life 650B I Front
- ZZYX Life 650B I Rear
- Schwalbe Johnny Watts 55-584 I Front
- Schwalbe Johnny Watts 55-584 I Rear
- SQ Lab 621 ERGOLUX active
- ZZYX Suspension Seatpost 30.9mm
- ZZYX SL Alloy Stem ICR
- ZZYX corratec Life Handlebar

The Rendering is for Reference only

**FARBE COLOR**



Silver | Red | Cool Grey



Black | Red White | Cool Grey

**BK28353**

**39 | 42 | 47 | 53 | 57**

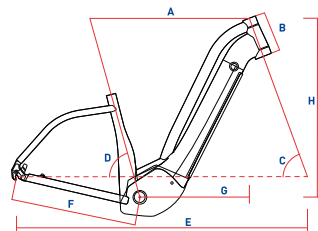

**CORRATEC LIFE | SHADOW EDGE TUBE 3.0**

CM	A	B	C	D	E	F	G	H
<b>39</b>	593	160	68	77	1181	460	443	653
<b>42</b>	601	170	68	77	1190	460	448	663
<b>47</b>	608	180	68	77	1199	460	453	673
<b>53</b>	616	190	69	77	1197	460	458	686
<b>57</b>	623	200	69	77	1205	460	463	696

**FEATURES**



# CORRATEC LIFE CX6

Extrem stabiler Shadow Edge Tube 2.0 Rahmen mit 180kg zulässigem Systemgewicht.

Maximale Verwindungssteifigkeit mit dem form-schönen, voll integrierten Powertube 625Wh.





















Hochwertige Komponenten sorgen für ein angenehmes und ergonomisches Fahrgefühl.

Outstanding:

Permissible system weight up to 180 Kg.

Shadow Edge Tube 2.0 for an elegant integration of the 625Wh Bosch battery.

The E-Bike SUV – Amazing performance both on and off the road.

-  Bosch Performance CX Cruise BES3 (25 km/h)
-  Bosch Power Tube 625Wh
-  Bosch Intuvia 100
-  corrateg Life
-  SR Suntour MOBIE25-AIR LOR DS 100mm
-  Enviolo Trekking
-  Enviolo Manual Controller
-  Magura MT Thirty 203mm I Front
-  Magura MT Thirty 180mm I Rear
-  ZZYX E-Power Crank 38T
-  Enviolo 20T
-  KMC Z1
-  ZZYX Life 650B I Front
-  ZZYX Life 650B I Rear
-  Schwalbe Johnny Watts 60-584 I Front
-  Schwalbe Johnny Watts 60-584 I Rear
-  SQ Lab 621 ERGOLUX active
-  ZZYX SP Alloy Seatpost 30.9mm
-  ZZYX SL Alloy Stem ICR
-  ZZYX corrateg Life Handlebar



**SE**  
20  
**625**  
Wh  
**85**  
Nm

The Rendering is for Reference only

FARBE COLOR



Silver | Red | Cool Grey



Black | Red White | Cool Grey

**BK28352**

**39 | 42 | 47 | 53 | 57**

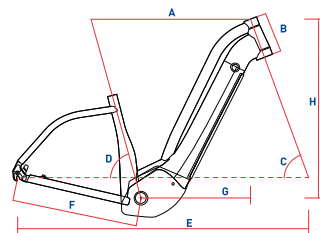

**CORRATEC LIFE | SHADOW EDGE TUBE 2.0**

CM	A	B	C	D	E	F	G	H
39	593	160	68	77	1181	460	443	653
42	601	170	68	77	1190	460	448	663
47	608	180	68	77	1199	460	453	673
53	616	190	69	77	1197	460	458	686
57	623	200	69	77	1205	460	463	696

**FEATURES**





# CORRATEC LIFE CX6 12S

Extrem stabiler Shadow Edge Tube 2.0 Rahmen mit 180kg zulässigem Systemgewicht.

Maximale Verwindungssteifigkeit mit dem form-schönen, voll integrierten Powertube 625Wh.

Hochwertige Komponenten sorgen für ein angenehmes und ergonomisches Fahrgefühl.

Outstanding:

Permissible system weight up to 180 Kg.

Shadow Edge Tube 2.0 for an elegant integration of the 625Wh Bosch battery.

The E-Bike SUV – Amazing performance both on and off the road.

**SE**  
20  
**625**  
Wh  
**85**  
Nm



- Bosch Performance CX Cruise BES3 (25 km/h)
- Bosch Power Tube 625Wh
- Bosch Intuvia 100
- corratec Life
- SR Suntour MOBIE25-AIR LOR DS 100mm
- Sram SX Eagle 12S
- Sram SX Eagle 12S
- Magura MT Thirty 203mm I Front
- Magura MT Thirty 180mm I Rear
- Sram X-Sync 38T
- Sram PG1210 Eagle 11-50T 12S
- Sram SX Eagle 12S
- ZZYX Life 650B I Front
- ZZYX Life 650B I Rear
- Schwalbe Johnny Watts 60-584 I Front
- Schwalbe Johnny Watts 60-584 I Rear
- SQ Lab 621 ERGOLUX active
- ZZYX Suspension Seatpost 30.9mm
- ZZYX SL Alloy Stem ICR
- ZZYX corratec Life Handlebar

The Rendering is for Reference only

**FARBE COLOR**



Silver | Red | Cool Grey



Black | Red White | Cool Grey

**BK28355**

**39 | 42 | 47 | 53 | 57**

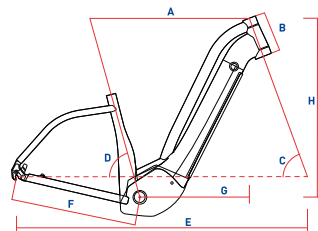

**CORRATEC LIFE I SHADOW EDGE TUBE 2.0**

CM	A	B	C	D	E	F	G	H
<b>39</b>	593	160	68	77	1181	460	443	653
<b>42</b>	601	170	68	77	1190	460	448	663
<b>47</b>	608	180	68	77	1199	460	453	673
<b>53</b>	616	190	69	77	1197	460	458	686
<b>57</b>	623	200	69	77	1205	460	463	696

**FEATURES**



# TREKKING

## —E-BIKE—

Um Deinen hohen Ansprüchen gerecht zu werden, entwickeln wir hochfunktionelle E-Trekking Bikes mit modernsten Technologien. Unsere E-Trekking Bike Range bietet Dir komfortable Tiefeinsteiger bis hin zu 26 Zoll City – Cruisern. Zusätzlich garantiert Dir unsere C29 S-Pedelec Serie bei längeren Pendelfahrten ein entspanntes Ankommen am Arbeitsplatz. Bei Deinen sportlichen Ausfahrten oder genüsslichen Touren ist das Rad Dein zuverlässiger Partner. Oberste Priorität ist es für uns, Dich mit Deinem Rad sicher und entspannt ans Ziel zu bringen.

In order to meet your expectations, we develop highly functional E-Trekking bikes with the latest technologies. Our range offers you comfortable 26 inch city cruisers. In addition, our C29 Pedelec series are the perfect bikes for daily commuting. Whether you go for a sporty ride or would like to do a multiple days trip in good company, with our E-Trekking bikes you are perfectly prepared at any time. Moreover our main purpose is that you feel safe and comfortable on your bike.

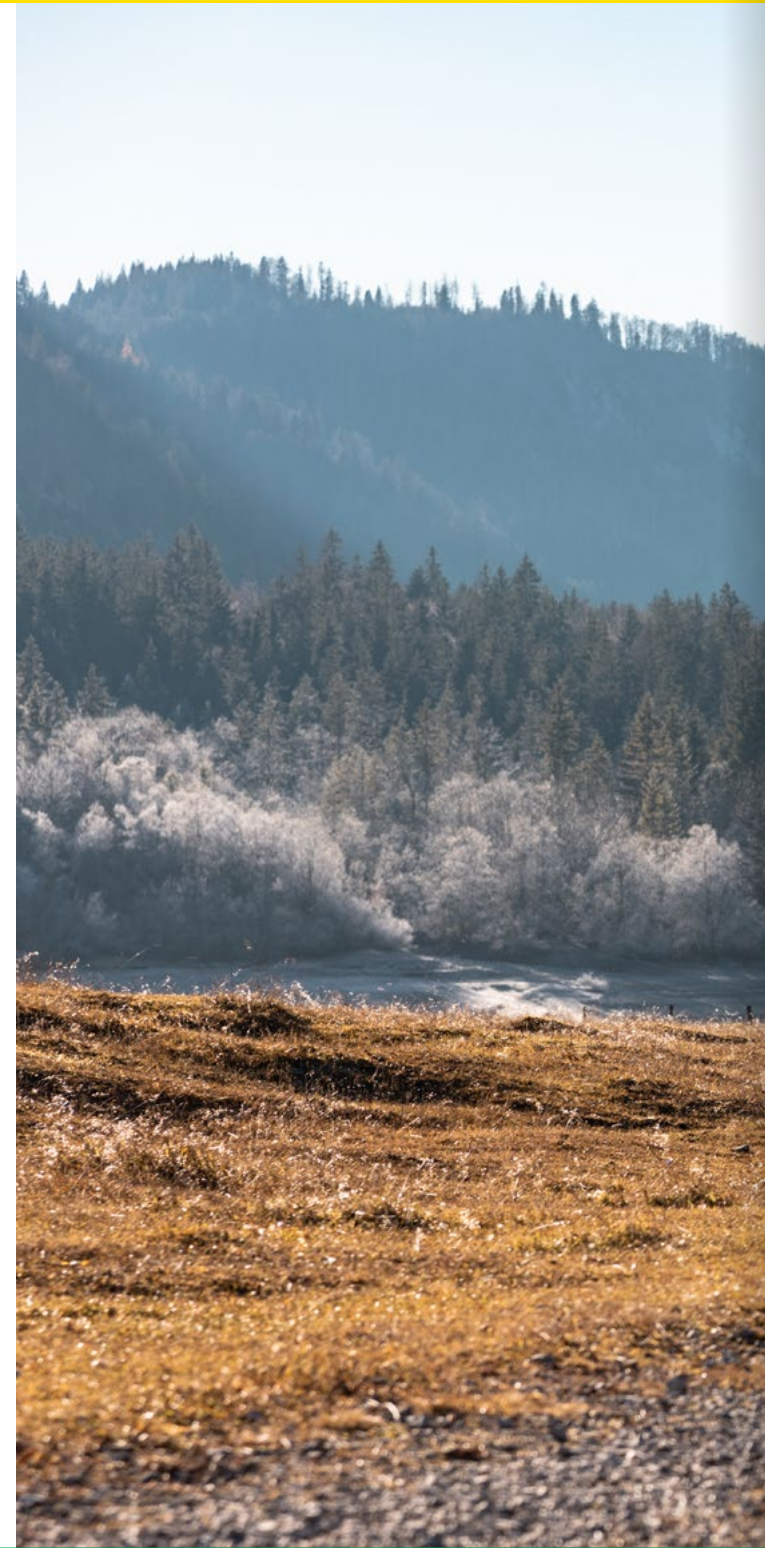







# E-POWER C29 SE 3.0 CX7 BELT TRAPEZ

Das absolute Premium-Highlight in dieser Produktreihe als komfortorientiertes Trekkingrad.













Die dämpfende 29 Zoll Ballonbereifung sorgt für ein angenehmes Cruisen auch auf Schotterstraßen.

Shadow Edge Tube 3.0 – weltweit stabilster und sicherster corratec E-Bike Rahmen.

The premium class among the trekking bikes – comfort optimized touring bike.

29er balloon tires for effortless gliding on gravel roads.

Shadow Edge Tube 3.0 – worldwide most stable and safest corratec E-Bike Frame.

-  Bosch Performance CX Cruise BES3 (25 km/h)
-  Bosch Power Tube 750Wh
-  Bosch Kiox 300
-  E-Power C29 Trapez
-  E-Power C29 Fork
-  Enviolo Trekking
-  Enviolo Manual Controller
-  Magura MT Thirty 180mm | Front
-  Magura MT Thirty 180mm | Rear
-  Gates 46T
-  Gates 22T
-  carbon drive belt
-  ZZYX Sport HD 29" | Front
-  ZZYX Sport HD 29" | Rear
-  Continental CONTACT Cruiser 55 - 622 | Front
-  Continental CONTACT Cruiser 55 - 622 | Rear
-  ZZYX Classic Leather Saddle
-  ZZYX SP Alloy Seatpost 30.9mm
-  ZZYX Speedlifter Classic
-  ZZYX SL Alloy Handlebar



**SE**  
3.0  
**750**  
Wh  
**85**  
Nm

The Rendering is for Reference only

FARBE COLOR  Chrome |  Cool Grey

**BK28340**

 45 | 50 | 55

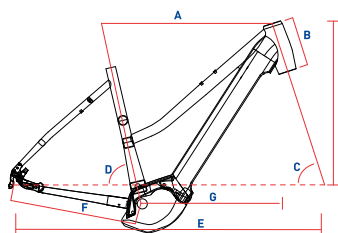

**E-POWER C29 TRAPEZ | SHADOW EDGE TUBE 3.0**

CM	A	B	C	D	E	F	G	H
45	617	170	69	73	1175	482	420	665
50	625	180	69	73	1185	482	426	674
55	644	190	69	73	1204	482	442	684

FEATURES





# E-POWER C29 SE 3.0 CX7 BELT GENT

Das absolute Premium-Highlight in dieser Produktreihe als komfortorientiertes Trekkingrad.

Die dämpfende 29 Zoll Ballonbereifung sorgt für ein angenehmes Cruisen auch auf Schotterstraßen.

12 Gang Kettenschaltung von Sram für bergiges Gelände.

The premium class among the trekking bikes – comfort optimized touring bike.

29er balloon tires for effortless gliding on gravel roads.

12-speed derailleur from Sram for mountainous terrain.

**SE**  
3.0  
**750**  
Wh  
**85**  
Nm



- Bosch Performance CX Cruise BES3 (25 km/h)
- Bosch Power Tube 750Wh
- Bosch Kiox 300
- E-Power C29 Gent
- E-Power C29 Fork
- Enviolo Trekking
- Enviolo Manual Controller
- Magura MT Thirty 180mm | Front
- Magura MT Thirty 180mm | Rear
- Gates 46T
- Gates 22T
- carbon drive belt
- ZZYX Sport HD 29" | Front
- ZZYX Sport HD 29" | Rear
- Continental CONTACT Cruiser 55 - 622 | Front
- Continental CONTACT Cruiser 55 - 622 | Rear
- ZZYX Classic Leather Saddle
- ZZYX SP Alloy Seatpost 30.9mm
- ZZYX Speedlifter Classic
- ZZYX SL Alloy Handlebar

The Rendering is for Reference only

**FARBE COLOR**

Chrome |  Cool Grey

**BK28341**

50 | 55 | 60

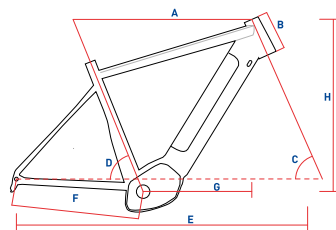

**E-POWER C29 GENT | SHADOW EDGE TUBE 3.0**

CM	A	B	C	D	E	F	G	H
50	625	160	69	73	1177	482	425	654
55	633	170	69	73	1186	482	430	663
60	641	180	69	73	1194	482	435	672

**FEATURES**



# E-POWER C29 SE 3.0 CX7 12S TRAPEZ

Das absolute Premium-Highlight in dieser Produktreihe als komfortorientiertes Trekkingrad.

Die dämpfende 29 Zoll Ballonbereifung sorgt für ein angenehmes Cruisen auch auf Schotterstraßen.

Shadow Edge Tube 3.0 – weltweit stabilster und sicherster corratec E-Bike Rahmen.

The premium class among the trekking bikes – comfort optimized touring bike.

29er balloon tires for effortless gliding on gravel roads.

Shadow Edge Tube 3.0 – worldwide most stable and safest corratec E-Bike Frame.

-  Bosch Performance CX Cruise BES3 (25 km/h)
-  Bosch Power Tube 750Wh
-  Bosch Intuvia 100
-  E-Power C29 Trapez
-  E-Power C29 Fork
-  Sram SX Eagle 12S
-  Sram SX Eagle 12S
-  Tektro HD-T275 180mm | Front
-  Tektro HD-T275 180mm | Rear
-  Sram X-Sync 38T
-  Sram PG1210 Eagle 11-50T 12S
-  Sram SX Eagle 12S
-  ZZYZX Sport HD 29" | Front
-  ZZYZX Sport HD 29" | Rear
-  Continental CONTACT Cruiser 55 - 622 | Front
-  Continental CONTACT Cruiser 55 - 622 | Rear
-  ZZYZX Classic Leather Saddle
-  ZZYZX SP Alloy Seatpost 30.9mm
-  ZZYZX Speedlifter Classic
-  ZZYZX SL Alloy Handlebar



**SE**  
3.0  
**750**  
Wh  
**85**  
Nm

The Rendering is for Reference only

FARBE COLOR

 Dark Blue |  Silver

**BK28342**

 45 | 50 | 55

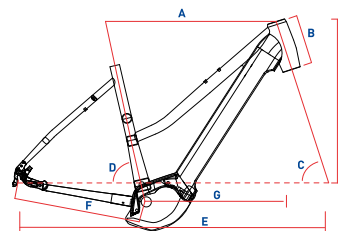

E-POWER C29 TRAPEZ | SHADOW EDGE TUBE 3.0

CM	A	B	C	D	E	F	G	H
45	617	170	69	73	1158	465	420	665
50	625	180	69	73	1168	465	426	674
55	644	190	69	73	1187	465	442	684

FEATURES





# E-POWER C29 SE 3.0 CX7 12S GENT

Das absolute Premium-Highlight in dieser Produktreihe als komfortorientiertes Trekkingrad.

Die dämpfende 29 Zoll Ballonbereifung sorgt für ein angenehmes Cruisen auch auf Schotterstraßen.

12 Gang Kettenschaltung von Sram für bergiges Gelände.

The premium class among the trekking bikes – comfort optimized touring bike.

29er balloon tires for effortless gliding on gravel roads.

12-speed derailleur from Sram for mountainous terrain.

**SE**  
3.0  
**750**  
Wh  
**85**  
Nm



- Bosch Performance CX Cruise BES3 (25 km/h)
- Bosch Power Tube 750Wh
- Bosch Intuvia 100
- E-Power C29 Gent
- E-Power C29 Fork
- Sram SX Eagle 12S
- Sram SX Eagle 12S
- Tektro HD-T275 180mm I Rear
- Tektro HD-T275 180mm I Front
- Sram X-SYNC 38T
- Sram PG1210 Eagle 11-50T 12S
- Sram SX Eagle 12S
- ZZYZX Sport HD 29" I Front
- ZZYZX Sport HD 29" I Rear
- Continental CONTACT Cruiser 55 - 622 I Front
- Continental CONTACT Cruiser 55 - 622 I Rear
- ZZYZX Classic Leather Saddle
- ZZYZX SP Alloy Seatpost 30.9mm
- ZZYZX Speedlifter Classic
- ZZYZX SL Alloy Handlebar

The Rendering is for Reference only

**FARBE COLOR** Dark Blue | Silver

**BK28343**

50 | 55 | 60

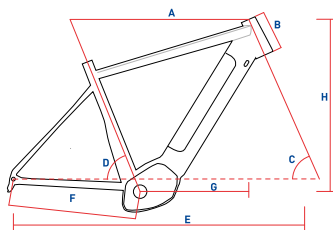

**E-POWER C29 GENT | SHADOW EDGE TUBE 3.0**

CM	A	B	C	D	E	F	G	H
50	625	160	69	73	1160	465	425	654
55	633	170	69	73	1168	465	430	663
60	641	180	69	73	1177	465	435	672

**FEATURES**



# E-POWER SPORT 28 SE 3.0 CX7 12S TRAPEZ

Der tiefe Einstieg bietet dem Fahrer zu jedem Zeitpunkt maximale Sicherheit und Kontrolle.



















Shadow Edge Tube 3.0 - Weltweit stabilster und sicherster corratec E-Bike Rahmen.

Hochwertige Komponenten garantieren ein breites Spektrum für den individuellen Einsatzbereich.

The low entry offers the rider maximum safety and control at all times.

The newly developed Shadow Edge 3.0 frame construction ensures maximum rigidity and enables the new 750Wh battery to be removed easily.

High quality components guarantee a wide range for the individual area of application.

-  Bosch Performance CX Cruise BES3 (25 km/h)
-  Bosch Power Tube 750Wh
-  Bosch Kiox 300
-  E-Power Sport 28 Trapez
-  SR Suntour MOBIE25-AIR LOR DS 63mm
-  Shimano Deore XT SGS 12S
-  Shimano SLX 12S
-  Shimano MT200 180mm I Front
-  Shimano MT200 180mm I Rear
-  ZZYZX E-Power Crank 38T
-  Shimano SLX 10-51T 12S
-  KMC X12 12S
-  ZZYZX Sport HD 28" I Front
-  ZZYZX Sport HD 28" I Rear
-  Schwalbe Land Cruiser 55-622 I Front
-  Schwalbe Land Cruiser 55-622 I Rear
-  Selle Royal Ariel Ladies
-  ZZYZX Suspension Seatpost 30.9mm
-  ZZYZX SL Alloy Stem 1CR
-  ZZYZX SL Alloy Handlebar



**SE**  
3.0  
**750**  
Wh  
**85**  
Nm

The Rendering is for Reference only

FARBE COLOR

 Dark Blue | Mango | Light Grey

**BK28332**

 45 | 50 | 55

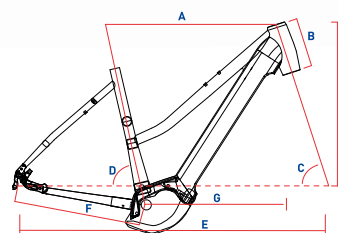

E-POWER SPORT 28 GENT | SHADOW EDGE TUBE 3.0

CM	A	B	C	D	E	F	G	H
45	612	170	69	74	1160	465	424	657
50	621	180	69	74	1169	465	430	666
55	629	190	69	74	1179	465	436	676

FEATURES





# E-POWER SPORT 28 SE 3.0 CX7 12S GENT

Der hochwertige Aluminium Rahmen bietet höchstmögliche Sicherheit und Stabilität.

Maximale Verwindungssteifigkeit mit dem neuen, voll integrierten Powertube 750Wh Akku.

Shadow Edge Tube 3.0 – weltweit stabilster und sicherster corrateg E-Bike Rahmen.

High-quality aluminum frame for more safety and stability on tours and in traffic.

Comfort optimized touring bike with suspension fork and suspension seatpost.

Shadow Edge Tube 3.0- worldwide most stable and safest corrateg E-Bike frame.

**SE<sup>3.0</sup>**  
**750<sup>Wh</sup>**  
**85<sup>Nm</sup>**



- Bosch Performance CX Cruise BES3 (25 km/h)
- Bosch Power Tube 750Wh
- Bosch Kiox 300
- E-Power Sport 28 Gent
- SR Suntour MOBIIE25-AIR LOR DS 63mm
- Shimano Deore XT SGS 12S
- Shimano SLX 12S
- Shimano MT200 180mm I Front
- Shimano MT200 180mm I Rear
- ZZYX E-Power Crank 38T
- Shimano SLX 10-51T 12S
- KMC X12 12S
- ZZYX Sport HD 28" I Front
- ZZYX Sport HD 28" I Rear
- Schwalbe Land Cruiser 55-622 I Front
- Schwalbe Land Cruiser 55-622 I Rear
- Selle Royal Ariel Men
- ZZYX Suspension Seatpost 30.9mm
- ZZYX SL Alloy Stem ICR
- ZZYX SL Alloy Handlebar

The Rendering is for Reference only

**FARBE COLOR**

Dark Blue | Mango | Light Grey

**BK28333**

50 | 55 | 60

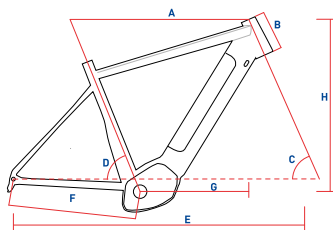

**E-POWER SPORT 28 TRAPEZ | SHADOW EDGE TUBE 3.0**

CM	A	B	C	D	E	F	G	H
50	630	160	68	73	1178	465	435	638
55	638	170	68	73	1187	465	440	647
60	645	180	68	73	1195	465	445	656

**FEATURES**



# E-POWER SPORT 28 SE 3.0 CX7 11S TRAPEZ

Der tiefe Einstieg bietet dem Fahrer zu jedem Zeitpunkt maximale Sicherheit und Kontrolle.





















Shadow Edge Tube 3.0 - Weltweit stabilster und sicherster corrated E-Bike Rahmen.

Hochwertige Komponenten garantieren ein breites Spektrum für den individuellen Einsatzbereich.

The low entry offers the rider maximum safety and control at all times.

The newly developed Shadow Edge 3.0 frame construction ensures maximum rigidity and enables the new 750Wh battery to be removed easily.

High quality components guarantee a wide range for the individual area of application.

-  Bosch Performance CX Cruise BES3 (25 km/h)
-  Bosch Power Tube 750Wh
-  Bosch Kiox 300
-  E-Power Sport 28 Trapez
-  SR Suntour MOBIE25-COIL LOR DS 63mm
-  L-TWOO A11-X 11S
-  L-TWOO A11-X 11S
-  Shimano MT200 180mm I Front
-  Shimano MT200 180mm I Rear
-  ZZYZX E-Power Crank 38T
-  L-TWOO A11 11-46T 11S
-  KMC X11
-  ZZYZX Sport HD 28° I Front
-  ZZYZX Sport HD 28° I Rear
-  Schwalbe Land Cruiser 55-622 I Front
-  Schwalbe Land Cruiser 55-622 I Rear
-  Selle Royal Ariel Ladies
-  ZZYZX Suspension Seatpost 30.9mm
-  ZZYZX SL Alloy Stem ICR
-  ZZYZX SL Alloy Handlebar



**SE**  
3.0  
**750**  
Wh  
**85**  
Nm

The Rendering is for Reference only

FARBE COLOR

    Light Grey | Dark Blue | Cool Grey | Intense Red

**BK28334**

 45 | 50 | 55

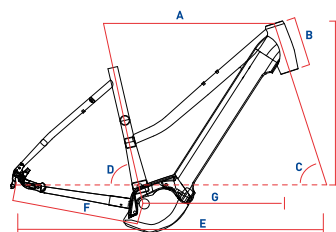

**E-POWER SPORT 28 GENT | SHADOW EDGE TUBE 3.0**

CM	A	B	C	D	E	F	G	H
45	612	170	69	74	1160	465	424	657
50	621	180	69	74	1169	465	430	666
55	629	190	69	74	1179	465	436	676

**FEATURES**





# E-POWER SPORT 28 SE 3.0 CX7 11S GENT

Der hochwertige Aluminium Rahmen bietet höchstmögliche Sicherheit und Stabilität.

Maximale Verwindungssteifigkeit mit dem voll integrierten Powertube 750Wh Akku.

Shadow Edge Tube 3.0 – weltweit stabilster und sicherster corratec E-Bike Rahmen.

High-quality aluminum frame for more safety and stability on tours and in traffic.

Comfort optimized touring bike with suspension fork and suspension seatpost.

Shadow Edge Tube 3.0 - worldwide most stable and safest corratec E-Bike frame.

**SE<sup>3.0</sup>**  
**750** Wh  
**85** Nm



- Bosch Performance CX Cruise BES3 (25 km/h)
- Bosch Power Tube 750Wh
- Bosch Kiox 300
- E-Power Sport 28 Gent
- SR Suntour MOBIE25-COIL LOR DS 63mm
- L-TW00 A11-X 11S
- L-TW00 A11-X 11S
- Shimano MT200 180mm I Front
- Shimano MT200 180mm I Rear
- ZYZX E-Power Crank 38T
- L-TW00 A11 11-46T 11S
- KMC X11
- ZYZX Sport HD 28" I Front
- ZYZX Sport HD 28" I Rear
- Schwalbe Land Cruiser 55-622 I Front
- Schwalbe Land Cruiser 55-622 I Rear
- Selle Royal Ariel Men
- ZYZX Suspension Seatpost 30.9mm
- ZYZX SL Alloy Stem ICR
- ZYZX SL Alloy Handlebar

The Rendering is for Reference only

**FARBE COLOR**

Light Grey | Dark Blue | Cool Grey | Intense Red

**BK28335**

50 | 55 | 60

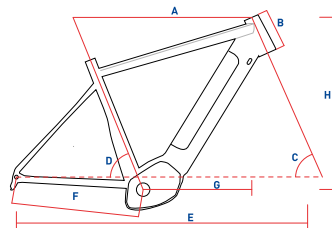

**E-POWER SPORT 28 TRAPEZ | SHADOW EDGE TUBE 3.0**

CM	A	B	C	D	E	F	G	H
50	630	160	68	73	1178	465	435	638
55	638	170	68	73	1187	465	440	647
60	645	180	68	73	1195	465	445	656

**FEATURES**



# E-POWER TREKKING 28 SE 3.0 CX7 12S WAVE

Der tiefe Einstieg bietet dem Fahrer zu jedem Zeitpunkt maximale Sicherheit und Kontrolle.





















Shadow Edge Tube 3.0 - Weltweit stabilster und sicherster corratec E-Bike Rahmen.

Hochwertige Komponenten garantieren ein breites Spektrum für den individuellen Einsatzbereich.

The low entry offers the rider maximum safety and control at all times.

The newly developed Shadow Edge 3.0 frame construction ensures maximum rigidity and enables the new 750Wh battery to be removed easily.

High quality components guarantee a wide range for the individual area of application.



-  Bosch Performance CX Cruise BES3 (25 km/h)
-  Bosch Power Tube 750Wh
-  Bosch Kiox 300
-  E-Power Trekking 28 Wave
-  SR Suntour NEX E25 DS 700C 63mm
-  Sram SX Eagle 12S
-  Sram SX Eagle 12S
-  Shimano MT200 180mm I Front
-  Shimano MT200 160mm I Rear
-  Sram X-Sync 38T
-  Sram PG1210 Eagle 11-50T 12S
-  Sram SX Eagle 12S
-  ZZYZX Trekking HD 28" I Front
-  ZZYZX Trekking HD 28" I Rear
-  SCHWALBE LAND CRUISER 55-622 I Front
-  SCHWALBE LAND CRUISER 55-622 I Rear
-  Selle Royal Ariel Ladies
-  ZZYZX Suspension Seatpost 30.9mm
-  ZZYZX SL Alloy Stem
-  ZZYZX Trekking Handlebar



**SE**  
3.0  
**750**  
Wh  
**85**  
Nm

The Rendering is for Reference only

FARBE COLOR

   Metallic Sand | Dirty Gold | Dark Silver

**BK28330**

 45 | 50 | 55

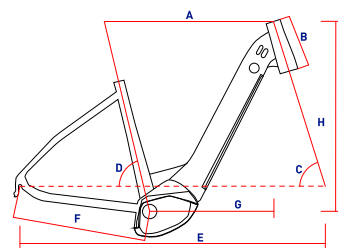

E-POWER TREKKING 28 WAVE | SHADOW EDGE TUBE 3.0

CM	A	B	C	D	E	F	G	H
45	601	180	68	74	1159	465	410	666
50	608	190	68	74	1168	465	415	676
55	616	200	68	74	1176	465	420	685

FEATURES





# E-POWER TREKKING 28 SE 3.0 CX7 12S GENT

Der hochwertige Aluminium Rahmen bietet höchstmögliche Sicherheit und Stabilität.

Maximale Verwindungssteifigkeit mit dem voll integrierten Powertube 750Wh Akku.

Shadow Edge Tube 3.0 – weltweit stabilster und sicherster corrateg E-Bike Rahmen.

High-quality aluminum frame for more safety and stability on tours and in traffic.

Comfort optimized touring bike with suspension fork and suspension seatpost.

Shadow Edge Tube 3.0 - worldwide most stable and safest corrateg E-Bike frame.

**SE**  
3.0  
**750**  
Wh  
**85**  
Nm



- Bosch Performance CX Cruise BES3 (25 km/h)
- Bosch Power Tube 750Wh
- Bosch Kiox 300
- E-Power Trekking 28 Gent
- SR Suntour NEX E25 DS 700C 63mm
- Sram SX Eagle 12S
- Sram SX Eagle 12S
- Shimano MT200 180mm I Front
- Shimano MT200 160mm I Rear
- Sram X-Sync 38T
- Sram PG1210 Eagle 11-50T 12S
- Sram SX Eagle 12S
- ZZYX Trekking HD 28" I Front
- ZZYX Trekking HD 28" I Rear
- SCHWALBE LAND CRUISER 55-622 I Front
- SCHWALBE LAND CRUISER 55-622 I Rear
- Selle Royal Ariel Men
- ZZYX Suspension Seatpost 30.9mm
- ZZYX SL Alloy Stem
- ZZYX Trekking Handlebar

The Rendering is for Reference only

**FARBE COLOR**

Metallic Sand | Dirty Gold | Dark Silver

**BK28331**

50 | 55 | 60

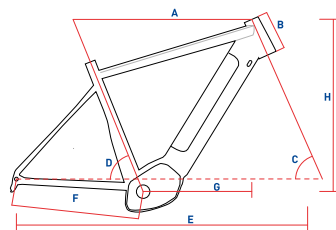

**E-POWER TREKKING 28 GENT | SHADOW EDGE TUBE 3.0**

**FEATURES**

CM	A	B	C	D	E	F	G	H
50	616	170	69	73	1156	465	423	654
55	628	180	69	73	1166	465	426	663
60	637	190	69	73	1175	465	432	673



# E-POWER TREKKING 28 CX6 12S WAVE

Der hochwertige Aluminium Rahmen bietet höchstmögliche Sicherheit und Stabilität.





















Maximale Verwindungssteifigkeit mit dem voll integrierten Powertube 625Wh Akku.

Shadow Edge Tube 2.0 – weltweit stabilster und sicherster corratec E-Bike Rahmen.

High-quality aluminum frame for more safety and stability on tours and in traffic.

Comfort optimized touring bike with suspension fork and suspension seatpost.

Shadow Edge Tube 2.0 - worldwide most stable and safest corratec E-Bike frame.

-  Bosch Performance CX Cruise BES3 (25 km/h)
-  Bosch Power Tube 625Wh
-  Bosch Intuvia 100
-  E-Power Trekking 28 Wave
-  SR Suntour NEX E25 DS 700C 63mm
-  Sram SX Eagle 12S
-  Sram SX Eagle 12S
-  Shimano MT200 180mm I Front
-  Shimano MT200 160mm I Rear
-  Sram X-SYNC 38T
-  Sram PG1210 Eagle 11-50T 12S
-  Sram SX Eagle 12S
-  ZZYZX Trekking HD 28" I Front
-  ZZYZX Trekking HD 28" I Rear
-  Schwalbe Land Cruiser 55-622 I Front
-  Schwalbe Land Cruiser 55-622 I Rear
-  Selle Royal Ariel Ladies
-  ZZYZX Suspension Seatpost 30.9mm
-  ZZYZX SL Alloy Stem
-  ZZYZX Trekking Handlebar



**SE**  
20  
**625**  
Wh  
**85**  
Nm

The Rendering is for Reference only

FARBE COLOR



Marine Blue | Neon Red | Silver

**BK28320**

 45 | 50 | 55

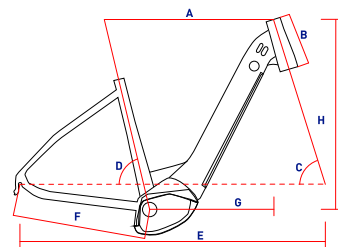

E-POWER TREKKING 28 WAVE | SHADOW EDGE TUBE 2.0

CM	A	B	C	D	E	F	G	H
45	601	180	68	74	1159	465	410	666
50	608	190	68	74	1168	465	415	676
55	616	200	68	74	1176	465	420	685

FEATURES





# E-POWER TREKKING 28 CX6 12S GENT

Der hochwertige Aluminium Rahmen bietet höchstmögliche Sicherheit und Stabilität.

Maximale Verwindungssteifigkeit mit dem voll integrierten Powertube 625Wh Akku.

Shadow Edge Tube 2.0 – weltweit stabilster und sicherster corratec E-Bike Rahmen.

High-quality aluminum frame for more safety and stability on tours and in traffic.

Comfort optimized touring bike with suspension fork and suspension seatpost.

Shadow Edge Tube 2.0 - worldwide most stable and safest corratec E-Bike frame.

**SE**  
20  
**625**  
Wh  
**85**  
Nm



- Bosch Performance CX Cruise BES3 (25 km/h)
- Bosch Power Tube 625Wh
- Bosch Intuvia 100
- E-Power Trekking 28 Gent
- SR Suntour NEX E25 DS 700C 63mm
- Sram SX Eagle 12S
- Sram SX Eagle 12S
- Shimano MT200 180mm I Front
- Shimano MT200 160mm I Rear
- Sram X-SYNC 38T
- Sram PG1210 Eagle 11-50T 12S
- Sram SX Eagle 12S
- ZZYX Trekking HD 28" I Front
- ZZYX Trekking HD 28" I Rear
- Schwalbe Land Cruiser 55-622 I Front
- Schwalbe Land Cruiser 55-622 I Rear
- Selle Royal Ariel Men
- ZZYX Suspension Seatpost 30.9mm
- ZZYX SL Alloy Stem
- ZZYX Trekking Handlebar

The Rendering is for Reference only

**FARBE COLOR**

Marine Blue | Neon Red | Silver

**BK28321**

50 | 55 | 60

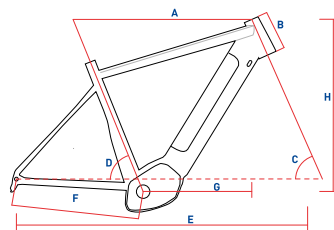

**E-POWER TREKKING 28 GENT | SHADOW EDGE TUBE 2.0**

CM	A	B	C	D	E	F	G	H
50	616	170	69	73	1156	465	423	654
55	628	180	69	73	1166	465	426	663
60	637	190	69	73	1175	465	432	673

**FEATURES**



# E-POWER TREKKING 28 P6 8SC WAVE

Der tiefe Einstieg und die ergonomische Geometrie erzielen maximalen Fahrspaß bei Touren oder im Stadtverkehr.

Die verbauten Dämpfer in der Gabel und Sattelstütze bieten maximalen Komfort und Entlastung.



Shadow Edge Tube Technologie - weltweit stabilster und sicherster corratec E-Bike Rahmen.

The low entry and the ergonomic geometry achieve maximum riding pleasure on tours and in city traffic.

Comfort optimized city bike with air fork and suspension seatpost.

SE<sup>20</sup>  
625<sub>Wh</sub>



-  Bosch Performance Line GEN3 60
-  Bosch Power Tube 625Wh
-  Bosch Intuvia 100
-  E-Power Trekking 28 Wave
-  SR Suntour NEX E25 DS 700C 63mm
-  Shimano Nexus 8S Coaster
-  Shimano Nexus Revo Shifter 8S
-  Shimano MT200 180mm I Front
-  Shimano MT200 160mm I Rear
-  **Rücktrittbremse**
-  ZYZX E-Power Crank 38T
-  Shimano 19T
-  KMC Z1 8S
-  ZYZX Trekking HD 28" I Front
-  ZYZX Trekking HD 28" I Rear
-  Schwalbe Land Cruiser 55-622 I Front
-  Schwalbe Land Cruiser 55-622 I Rear
-  Selle Royal Ariel Ladies
-  ZYZX Suspension Seatpost 30.9mm
-  ZYZX SL Alloy Stem
-  ZYZX Trekking Handlebar

The Rendering is for Reference only

FARBE COLOR

 Silver Grey | Dark Blue | Yellow Green

**BK28323**

 45 | 50 | 55

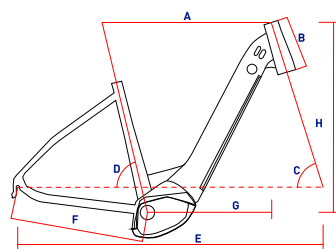

E-POWER TREKKING 28 WAVE | SHADOW EDGE TUBE 2.0

CM	A	B	C	D	E	F	G	H
45	620	175	69	73	1189	490	424	659
50	630	185	69	73	1199	490	431	668
55	640	195	69	73	1210	490	439	677



FEATURES





# E-POWER TREKKING 28 P6 8S WAVE

Der tiefe Einstieg und die ergonomische Geometrie erzielen maximalen Fahrspaß bei Touren oder im Stadtverkehr.

Die verbauten Dämpfer in der Gabel und Sattelstütze bieten maximalen Komfort und Entlastung.

Shadow Edge Tube Technologie - weltweit stabilster und sicherster corrated E-Bike Rahmen.

The low entry and the ergonomic geometry achieve maximum riding pleasure on tours and in city traffic.

Comfort optimized city bike with air fork and suspension seatpost.

Shadow Edge Tube Technology worldwide most stable and safest corrated e-bike frame

**SE<sub>20</sub>**  
**625**  
*Wh*



- Bosch Performance Line GEN3 60
- Bosch Power Tube 625Wh
- Bosch Intuvia 100
- E-Power Trekking 28 Wave
- SR Suntour NEX E25 DS 700C 63mm
- Shimano Nexus 8S
- Shimano Nexus Revo Shifter 8S
- Shimano MT200 180mm I Front
- Shimano MT200 160mm I Rear
- ZZYZX E-Power Crank 38T
- Shimano 19T
- KMC Z1 8S
- ZZYZX Trekking HD 28" I Front
- ZZYZX Trekking HD 28" I Rear
- Schwalbe Land Cruiser 55-622 I Front
- Schwalbe Land Cruiser 55-622 I Rear
- Selle Royal Ariel Ladies
- ZZYZX Suspension Seatpost 30.9mm
- ZZYZX SL Alloy Stem
- ZZYZX Trekking Handlebar

The Rendering is for Reference only

**FARBE COLOR** Green | Pearlized Black | Chrome

**BK28322**

45 | 50 | 55

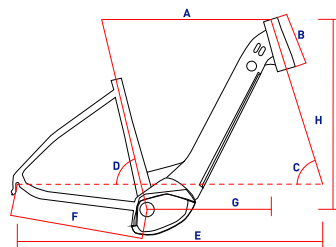

**E-POWER TREKKING 28 WAVE | SHADOW EDGE TUBE 2.0**

CM	A	B	C	D	E	F	G	H
45	620	175	69	73	1189	490	424	659
50	630	185	69	73	1199	490	431	668
55	640	195	69	73	1210	490	439	677

**FEATURES**



# E-POWER URBAN 28 AP5 8SC WAVE

Der tiefe Einstieg und die ergonomische Geometrie erzielen maximalen Fahrspaß bei Touren oder im Stadtverkehr.





















Die verbauten Dämpfer in der Gabel und Sattelstütze bieten maximalen Komfort und Entlastung.

Fusion Tube Edge Technologie - weltweit stabilster und sicherster corratec E-Bike Rahmen.

The low entry and the ergonomic geometry achieve maximum riding pleasure on tours and in city traffic.

Comfort optimized city bike with air fork and suspension seatpost.

Fusion Tube Edge Technology worldwide most stable and safest corratec e-bike frame

-  Bosch Active Line Plus (25km/h)
-  Bosch Power Pack 500Wh
-  Bosch Intuvia Display
-  E-Power Urban 28 Wave
-  SR Suntour NEX DS 700C 63mm
-  Shimano Nexus 8S Coaster
-  Shimano Nexus Revo Shifter 8S
-  Shimano MT200 180mm I Front
-  Shimano MT200 160mm I Rear
-  **Rücktrittbremse**
-  ZYZX E-Power Crank 38T
-  Shimano 19T
-  KMC Z1 8S
-  ZYZX Urban HD 28" I Front
-  ZYZX Urban HD 28" I Rear
-  Schwalbe Energizer Active Plus 50-622 I Front
-  Schwalbe Energizer Active Plus 50-622 I Rear
-  Selle Royal Ariel Ladies
-  ZYZX Suspension Seatpost 30.9mm
-  ZYZX SL Alloy Stem
-  ZYZX Trekking Handlebar



The Rendering is for Reference only

FARBE COLOR



Cool Grey | Red

**BK28310**

 45 | 50 | 55

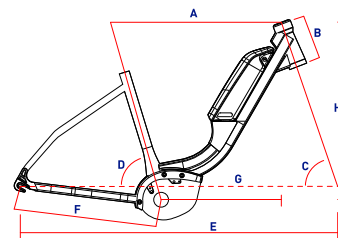

E-POWER URBAN 28 WAVE | FUSION TUBE EDGE TECHNOLOGIE FEATURES

CM	A	B	C	D	E	F	G	H
45	590	180	69	73	1149	490	384	671
50	600	195	69	73	1160	490	390	685
55	610	210	69	73	1171	490	396	699







# E-POWER URBAN 28 AP5 8S WAVE

Der tiefe Einstieg und die ergonomische Geometrie erzielen maximalen Fahrspaß bei Touren oder im Stadtverkehr.

Die verbauten Dämpfer in der Gabel und Sattelstütze bieten maximalen Komfort und Entlastung.

Fusion Tube Edge Technologie - weltweit stabilster und sicherster corrated E-Bike Rahmen.

The low entry and the ergonomic geometry achieve maximum riding pleasure on tours and in city traffic.

Comfort optimized city bike with air fork and suspension seatpost.

Fusion Tube Edge Technology worldwide most stable and safest corrated e-bike frame.



- Bosch Active Line Plus (25km/h)
- Bosch Power Pack 500Wh
- Bosch Intuvia Display
- E-Power Urban 28 Wave
- SR Suntour NEX DS 700C 63mm
- Shimano Nexus 8S
- Shimano Nexus Revo Shifter 8S
- Shimano MT200 180mm I Front
- Shimano MT200 160mm I Rear
- ZZYZX E-Power Crank 38T
- Shimano Nexus 19T 8S
- KMC Z1 8S
- ZZYZX Urban HD 28" I Front
- ZZYZX Urban HD 28" I Rear
- Schwalbe Energizer Active Plus 50-622 I Front
- Schwalbe Energizer Active Plus 50-622 I Rear
- Selle Royal Ariel Ladies
- ZZYZX Suspension Seatpost 30.9mm
- ZZYZX SL Alloy Stem
- ZZYZX Trekking Handlebar

The Rendering is for Reference only

**FARBE COLOR**

Beige | Cool Grey | Warm Grey

**BK28311**

45 | 50 | 55

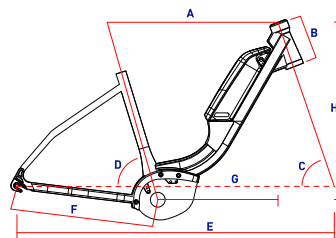

**E-POWER URBAN 28 WAVE | FUSION TUBE EDGE TECHNOLOGIE**

**FEATURES**

CM	A	B	C	D	E	F	G	H
45	590	180	69	73	1149	490	384	671
50	600	195	69	73	1160	490	390	685
55	610	210	69	73	1171	490	396	699



# E-POWER URBAN 28 AP5 11S WAVE

Maximales Vertrauen durch einen extrem tiefen Einstieg, um schnellstmöglich auf- und abzustiegen.





















Durchstiegsschutz aus hochwertigem Kunststoff und zusätzlich glasfaserverstärkt.

Direct Mount Gepäckträger bis 25kg belastbar mit stylish integriertem Rücklicht.

Low entry to get on and off the bike as fast as possible.

Entry cover made of high-quality elastomer and additionally reinforced with fiberglass.

Direct mount luggage carrier with a load capacity of up to 25kg with a stylish integrated rear light.

-  Bosch Active Line Plus (25km/h)
-  Bosch Power Pack 500Wh
-  Bosch Intuvia Display
-  E-Power Urban 28 Wave
-  SR Suntour NEX DS 26" 63mm
-  L-TWOO A11-X 11S
-  L-TWOO A11-X 11S
-  Shimano MT200 180mm I Front
-  Shimano MT200 160mm I Rear
-  ZZYX E-Power Crank 38T
-  L-TWOO A11 11-46T 11S
-  KMC X11
-  ZZYX Urban HD 28" I Front
-  ZZYX Urban HD 28" I Rear
-  Schwalbe Energizer Active Plus 50-622 I Front
-  Schwalbe Energizer Active Plus 50-622 I Rear
-  Selle Royal Ariel Ladies
-  ZZYX Suspension Seatpost 30.9mm
-  ZZYX SL Alloy Stem
-  ZZYX Trekking Handlebar



The Rendering is for Reference only

FARBE COLOR



Dark Blue | Silver light Blue | Light Blue

**BK28312**

45 | 50 | 55

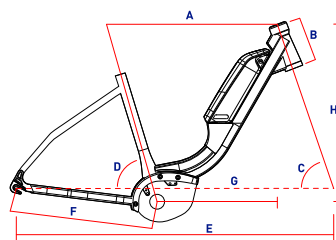

**E-POWER URBAN 28 WAVE**

CM	A	B	C	D	E	F	G	H
45	590	180	69	73	1160	490	384	671
50	600	195	69	73	1160	490	390	685
55	610	210	69	73	1171	490	396	699

**FEATURES**





# E-POWER URBAN 28 AP5 11S GENT

Maximales Vertrauen durch einen extrem tiefen Einstieg, um schnellstmöglich auf- und abzusteigen.

Durchstiegsschutz aus hochwertigem Kunststoff und zusätzlich glasfaserverstärkt.

Direct Mount Gepäckträger bis 25kg belastbar mit stylish integriertem Rücklicht.

Low entry to get on and off the bike as fast as possible.

Entry cover made of high-quality elastomer and additionally reinforced with fiberglass.

Direct mount luggage carrier with a load capacity of up to 25kg with a stylish integrated rear light.



- Bosch Active Line Plus (25km/h)
- Bosch Power Pack 500Wh
- Bosch Intuvia Display
- E-Power Urban 28 Wave
- SR Suntour NEX DS 26" 63mm
- L-TWOO A11-X 11S
- L-TWOO A11-X 11S
- Shimano MT200 180mm I Front
- Shimano MT200 160mm I Rear
- Sram X-Sync 38T
- L-TWOO A11 11-46T 11S
- KMC X11
- ZYZX Urban HD 28" I Front
- ZYZX Urban HD 28" I Rear
- Schwalbe Energizer Active Plus 50-622 I Front
- Schwalbe Energizer Active Plus 50-622 I Rear
- Selle Royal Ariel Ladies
- ZYZX Suspension Seatpost 30.9mm
- ZYZX SL Alloy Stem
- ZYZX Trekking Handlebar

The Rendering is for Reference only

**FARBE COLOR**

Dark Blue | Silver light Blue | Light Blue

**BK28313**

50 | 55 | 60

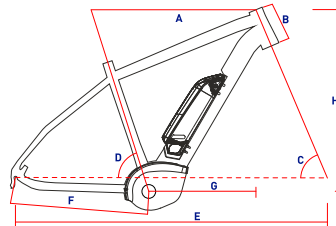

**E-POWER URBAN 28 WAVE**

CM	A	B	C	D	E	F	G	H
50	605	160	69	73	1162	490	405	653
55	615	175	69	73	1173	490	411	667
60	625	190	69	73	1184	490	416	681

**FEATURES**



# E-POWER CITY 26 AP5 8SC WAVE

## E-POWER 26

Maximales Vertrauen durch einen extrem tiefen Einstieg, um schnellstmöglich auf- und abzu steigen.

Durchstiegsschutz aus hochwertigem Kunststoff und zusätzlich glasfaserverstärkt.

Direct Mount Gepäckträger bis 25kg belastbar mit stylisch integriertem Rücklicht.

Low entry to get on and off the bike as fast as possible.

Entry cover made of high-quality elastomer and additionally reinforced with fiberglass.

Direct mount luggage carrier with a load capacity of up to 25kg with a stylish integrated rear light.

-  Bosch Active Line Plus (25km/h)
-  Bosch Power Pack 500Wh
-  Bosch Intuvia Display
-  E-Power City 26 Wave
-  SR Suntour NEX DS 26" 63mm
-  Shimano Nexus 8S Coaster
-  Shimano Nexus Revo Shifter 8S
-  Shimano MT200 180mm I Front
-  Shimano MT200 160mm I Rear
-  **Rücktrittbremse**
-  ZYZX E-Power Crank 38T
-  Shimano 19T 8S
-  KMC Z1 8S
-  ZYZX City HD 26" I Front
-  ZYZX City HD 26" I Rear
-  Schwalbe Delta Cruiser Plus 50-559 I Front
-  Schwalbe Delta Cruiser Plus 50-559 I Rear
-  Selle Royal Ariel Ladies
-  ZYZX Suspension Seatpost 30.9mm
-  ZYZX SL Alloy Stem
-  ZYZX Trekking Handlebar



The Rendering is for Reference only

FARBE COLOR

   Dark Red | Silver | Light Brown

**BK28300**

 40 | 45 | 50

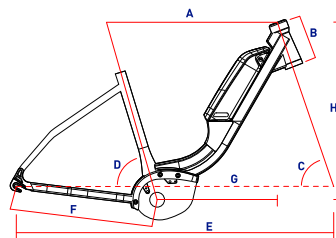

**E-POWER CITY 26 WAVE**

CM	A	B	C	D	E	F	G	H
40	580	175	69	73	1111	460	391	616
45	610	180	69	73	1141	460	420	621
50	612	195	69	73	1145	460	418	635

 **Coaster**

FEATURES





# E-POWER CITY 26 AP5 12S WAVE

**EPOWER<sub>26</sub>**

Maximales Vertrauen durch einen extrem tiefen Einstieg, um schnellstmöglich auf- und abzusteigen.

Durchstiegsschutz aus hochwertigem Kunststoff und zusätzlich glasfaserverstärkt.

Direct Mount Gepäckträger bis 25kg belastbar mit stylish integriertem Rücklicht.

Low entry to get on and off the bike as fast as possible.

Entry cover made of high-quality elastomer and additionally reinforced with fiberglass.

Direct mount luggage carrier with a load capacity of up to 25kg with a stylish integrated rear light.



- Bosch Active Line Plus (25km/h)
- Bosch Power Pack 500Wh
- Bosch Intuvia Display
- E-Power City 26 Wave
- SR Suntour NEX DS 26" 63mm
- Sram SX Eagle 12S
- Sram SX Eagle 12S
- Shimano MT200 180mm I Front
- Shimano MT200 160mm I Rear
- Sram X-Sync 38T
- Sram PG1210 Eagle 11-50T 12S
- Sram SX Eagle 12S
- ZZYX City HD 26" I Front
- ZZYX City HD 26" I Rear
- Schwalbe Delta Cruiser Plus 50-559 I Front
- Schwalbe Delta Cruiser Plus 50-559 I Rear
- Selle Royal Ariel Ladies
- ZZYX Suspension Seatpost 30.9mm
- ZZYX SL Alloy Stem
- ZZYX Trekking Handlebar

The Rendering is for Reference only

**FARBE COLOR**

Anthracite | Silver | Turquoise Green

**BK28301**

40 | 45 | 50

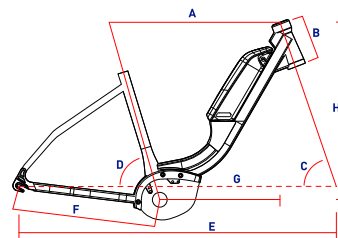

**E-POWER CITY 26 WAVE**

CM	A	B	C	D	E	F	G	H
40	580	175	69	73	1111	460	391	616
45	610	180	69	73	1141	460	420	621
50	612	195	69	73	1145	460	418	635

**FEATURES**





# THE ROADBIKE

Du bist süchtig nach dem Rausch der Geschwindigkeit und gehst an Deine Grenzen. Die Straße ist Deine Heimat und Deine ganze Leidenschaft steckt im Rennradfahren, steile Pässe und ausdauernde Passagen zu bezwingen. Das unbeschreibliche Gefühl zu erleben, das Unmachbare doch geschafft zu haben! Exakt diese Einstellung treibt uns immer wieder an für Dich neue Rennmaschinen zu entwickeln und in Raubling, im Herzen Bayerns fertigzustellen.

You are addicted to the feeling of speed, in the saddle you push your body to the next level. Road cycling is not only a sport for you, road cycling is pure passion and lifestyle. Steep climbs and gnarly downhills are your choice in cycling. The indescribable feeling of achieving impossible goals. With this passion and with an eye for detail corratec develops and produces, road bikes for every purpose.









# CCT EVO

A technical line drawing of a road bike frame and front assembly, showing the head tube, top tube, down tube, seat tube, and front fork. The drawing is rendered in a light gray color, with some parts highlighted in a darker gray to show depth and shading. The bike is oriented horizontally, facing right.

**800<sub>GR</sub>**

**Rahmengewicht ohne  
Lackierung**  
Frame weight without Paint

---

**AXS**  
12S

**Kabelloses Schalten**  
Wireless Shifting

---

**30<sub>WATT</sub>**

**Ersparnis durch verbesserte  
Aerodynamik**  
savings through improved  
aerodynamics

**FAST**  
**JUST GOT FASTER**



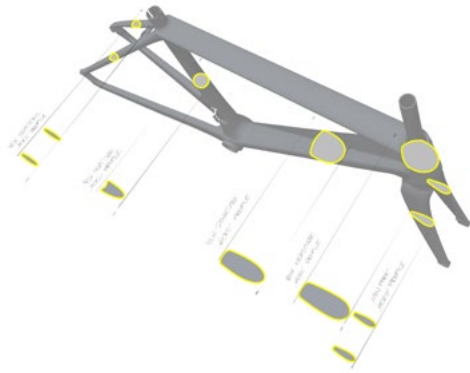

## PERFEKTE AERODYNAMIK PERFECT AERODYNAMIC

Der Rahmen wurde an den nentralgischen Punkten, Gabel, Steuer- und Unterrohr, aerodynamisch auf Perfektion getrimmt. Das Ergebnis: Ein unglaublicher Vorteil von 30 Watt.

The frame was aerodynamically trimmed to perfection at the important points such as the fork, head tube and down tube. The result: an incredible advantage of 30 watts.

## RACE COCKPIT

Rennfahren wie die Profis. Dank ergonomischer Lenkerdrops die speziell an die Taillierung der Daumen angepasst wurden, kannst du eine perfekte aerodynamische Position einnehmen und fühlst dich dabei noch pudelwohl. Eine Computer Mount ist integriert und fügt sich formschön in die Optik des Cockpits ein.

Race like the pros. Thanks to ergonomic handlebar drops that have been specially adapted to the waist of the thumbs, you can adopt a perfect aerodynamic position and still feel very comfortable. A computer mount is integrated and fits beautifully into the look of the cockpit.

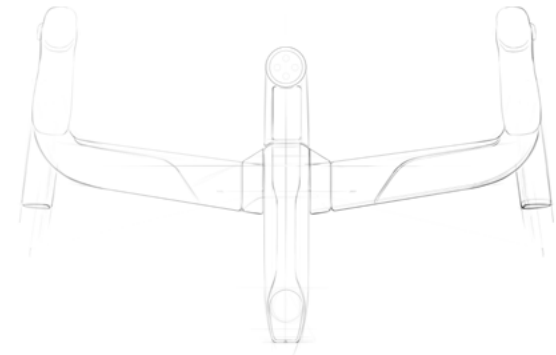

## SPORTLICH & AGGRESSIV SPORTY & AGGRESSIVE

Das neue CCT EVO ist sportlicher aggressiver unterwegs als sein Vorgänger. Dafür wurde der Faktor bzw. das Verhältnis zwischen Reach & Stack neu definiert. Der Reach ist länger und der Stack tiefer. Mit dieser sportlichen Sitzposition die gleichzeitig auch komfortabel ist gewinnst du zusätzliche 8 Watt.

The new CCT EVO is sportier and more aggressive than its predecessor. To achieve this, the factor or the relationship between reach and stack has been redefined. The reach is longer and the stack lower. With this sporty seating position, which is also comfortable, you gain an additional 8 watts.

# CCT EVO FACTORY

## CCT EVO

Ultraleichter und aerodynamischer „Boomerang Line“ voll Carbon Lenker und Rahmen.

Integrierte Computer Mount für eine formschöne Optik im Cockpit.



















Elektronische Sram Red eTAP AXS Schaltgruppe für flüssige Schaltvorgänge.

Ultralight and aerodynamic «Boomerang Line» full carbon handlebar and frame.

Integrated computer mount for a shapely look in the cockpit.

Electronic Sram Red eTAP switching group for fluid gear changes.



-  CCT EVO SL Disc
-  Road Carbon Fork Disc
-  Sram Red eTAP AXS 12S
-  Sram Red eTAP AXS
-  Sram Red eTAP AXS 12S
-  Sram Red eTAP AXS 160mm I Front
-  Sram Red eTAP AXS 160mm I Rear
-  Sram Red D1 DUB 172.5mm 48 I 35T
-  Sram XG1290 D1 10-33T 12S
-  Sram Red D1 12S
-  ZZYZX 700C Carbon I Front
-  ZZYZX 700C Carbon I Rear
-  Pirelli P Zero Race TLR 700 x 26C I Front
-  Pirelli P Zero Race TLR 700 x 26C I Rear
-  Selle Italia SLR Boost Superflow Carbon
-  Carbon Aero Seatpost
-  corrateg carbon stem I ICR
-  corrateg Road carbon Handlebar I ICR

The Rendering is for Reference only

FARBE COLOR



Reflex Blue I Pearlized Black



Factory Copper I Pearlized Black

**BK28100**

 46 | 48 | 51  
54 | 57 | 60

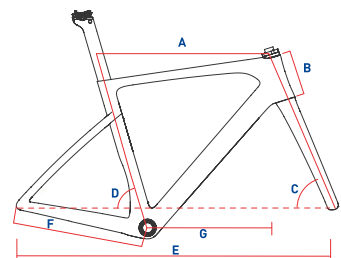

**CCT EVO**

CM	A	B	C	D	E	F	G	H
46	524	101	73	74	966	407	379	504
48	531	112	73	74	974	408	383	515
51	540	130	73	74	984	409	387	532
54	554	149	73	74	997	410	393	550
57	571	173	73	74	1013	411	401	573
60	588	201	73	74	1032	412	411	599

FEATURES





# CCT EVO FACTORY SR

**CCT EVO**

Ultraleichter und aerodynamischer „Bumerang Line“ voll Carbon Lenker und Rahmen.

Integrierte Computer Mount für eine formschöne Optik im Cockpit.

Elektronische Campagnolo Super Record Schaltgruppe für flüssige Schaltvorgänge.

Ultralight and aerodynamic «Boomerang Line» full carbon handlebar and frame.

Integrated computer mount for a shapely look in the cockpit.

Electronic Campagnolo Super Record switching group for fluid gear changes.





-  CCT EVO SL Disc
-  Road Carbon Fork Disc
-  Campagnolo Super Record 12S
-  Campagnolo Super Record
-  Campagnolo Super Record Wireless 12S
-  Campagnolo Super Record 160mm I Front
-  Campagnolo Super Record 160mm I Rear
-  Campagnolo Super Record Carbon 34 I 50T
-  Campagnolo Super Record 10-29T 12S
-  Campagnolo Super Record 12S
-  ZZYZYX AR56 CL disc 30mm 24H I Front
-  ZZYZYX AR56 CL disc 30mm 24H I Rear
-  Pirelli P Zero Race TLR 700 x 26C I Front
-  Pirelli P Zero Race TLR 700 x 26C I Rear
-  Selle Italia SLR Boost Superflow Carbon
-  Carbon Aero Seatpost
-  corratec carbon stem I ICR
-  corratec Road carbon Handlebar I ICR

The Rendering is for Reference only

**FARBE COLOR**

-  Reflex Blue I Pearlized Black
-  Factory Copper I Pearlized Black

**BK28103**

 46 | 48 | 51  
 54 | 57 | 60

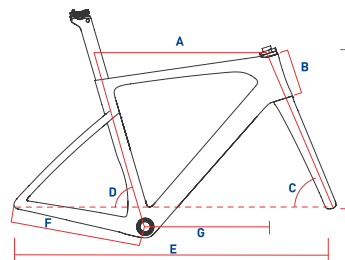

**CCT EVO**

CM	A	B	C	D	E	F	G	H
46	524	101	73	74	966	407	379	504
48	531	112	73	74	974	408	383	515
51	540	130	73	74	984	409	387	532
54	554	149	73	74	997	410	393	550
57	571	173	73	74	1013	411	401	573
60	588	201	73	74	1032	412	411	599

**FEATURES**



# CCT EVO PRO

## CCT EVO

Ultraleichter und aerodynamischer „Bumerang Line“ voll Carbon Lenker und Rahmen.

Integrierte Computer Mount für eine formschöne Optik im Cockpit.

Elektronische Sram Force eTAP AXS Schaltgruppe für flüssige Schaltvorgänge.

Ultralight and aerodynamic «Boomerang Line» full carbon handlebar and frame.

Integrated computer mount for a shapely look in the cockpit.

Electronic Sram Force eTAP switching group for fluid gear changes.



- CCT EVO SL Disc
- Road Carbon Fork Disc
- Sram Force eTAP AXS 12S
- Sram Force eTAP AXS
- Sram Force eTAP AXS 12S
- Sram Force eTAP AXS 160mm I Front
- Sram Force eTAP AXS 160mm I Rear
- Sram Force DUB 48 I 35T
- Sram XG1270 D1 10-33T 12S
- Sram Force D1 12S
- Mavic Ksyrium S 25 Disc CL I Front
- Mavic Ksyrium S 25 Disc CL I Rear
- Pirelli P Zero Race TLR 700 x 26C I Front
- Pirelli P Zero Race TLR 700 x 26C I Rear
- Selle Italia Novus Boost Evo
- Carbon Aero Seatpost
- Corratec carbon stem I ICR
- Corratec Road carbon Handlebar I ICR

The Rendering is for Reference only

**FARBE COLOR**



Reflex Blue | Pearlized Black



Factory Copper | Pearlized Black

**BK28101**

46 | 48 | 51  
54 | 57 | 60

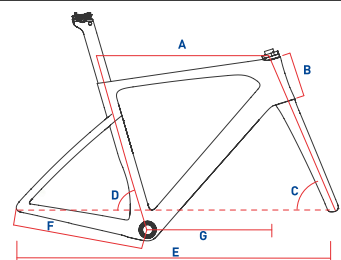

**CCT EVO**

CM	A	B	C	D	E	F	G	H
46	524	101	73	74	966	407	379	504
48	531	112	73	74	974	408	383	515
51	540	130	73	74	984	409	387	532
54	554	149	73	74	997	410	393	550
57	571	173	73	74	1013	411	401	573
60	588	201	73	74	1032	412	411	599

**FEATURES**





# CCT EVO RACE

CCT EVO

Ultraleichter und aerodynamischer „Bumerang Line“ voll Carbon Lenker und Rahmen.

Integrierte Computer Mount für eine formschöne Optik im Cockpit.

















Elektronische Sram Rival eTAP AXS Schaltgruppe für flüssige Schaltvorgänge.

Ultralight and aerodynamic «Boomerang Line» full carbon handlebar and frame.

Integrated computer mount for a shapely look in the cockpit.

Electronic Sram Rival eTAP switching group for fluid gear changes.





-  CCT EVO SL Disc
-  Road Carbon Fork Disc
-  Sram Rival eTAP AXS 12S
-  Sram Rival eTAP AXS
-  Sram Rival eTAP AXS 12S
-  Sram Rival AXS 160mm I Front
-  Sram Rival AXS 160mm I Rear
-  Sram Rival DUB 46 I 33T
-  Shimano CS-HG50 11-32T 10S
-  Sram Force D1 12S
-  Mavic Ksyrium S 25 Disc CL I Front
-  Mavic Ksyrium S 25 Disc CL I Rear
-  Pirelli P Zero Race TLR 700 x 26C I Front
-  Pirelli P Zero Race TLR 700 x 26C I Rear
-  Selle Italia Novus Boost Evo
-  Carbon Aero Seatpost
-  corratec carbon stem I ICR
-  corratec Road carbon Handlebar I ICR

The Rendering is for Reference only

FARBE COLOR

-  Reflex Blue I Pearlized Black
-  Factory Copper I Pearlized Black

**BK28102**

 46 | 48 | 51  
 54 | 57 | 60

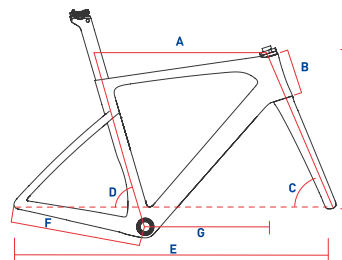

**CCT EVO**

CM	A	B	C	D	E	F	G	H
46	524	101	73	74	966	407	379	504
48	531	112	73	74	974	408	383	515
51	540	130	73	74	984	409	387	532
54	554	149	73	74	997	410	393	550
57	571	173	73	74	1013	411	401	573
60	588	201	73	74	1032	412	411	599

**FEATURES**



# CCT EVO CHORUS

## CCT EVO

Ultraleichter und aerodynamischer „Bumerang Line“ voll Carbon Lenker und Rahmen.

Integrierte Computer Mount für eine formschöne Optik im Cockpit.



Campagnolo Chorus Schaltgruppe für flüssige Schaltvorgänge.

Ultralight and aerodynamic «Boomerang Line» full carbon handlebar and frame.

Integrated computer mount for a shapely look in the cockpit.

Campagnolo Chorus switching group for fluid gear changes.



-  CCT EVO SL Disc
-  Road Carbon Fork Disc
-  Campagnolo Chorus 12S
-  Campagnolo Chorus
-  Campagnolo Chorus 12S
-  Campagnolo Chorus 160mm I Front
-  Campagnolo Chorus 160mm I Rear
-  Campagnolo Chorus 34 I 50T
-  Campagnolo Super Record 11-34T 12S
-  Campagnolo Chorus 12S
-  Ursus Miura TC37 Disc I Front
-  Ursus Miura TC37 Disc I Rear
-  Pirelli P Zero Race TLR 700 x 26C I Front
-  Pirelli P Zero Race TLR 700 x 26C I Rear
-  Selle Italia Novus Boost Evo
-  Carbon Aero Seatpost
-  corrateg carbon stem I ICR
-  corrateg Road carbon Handlebar I ICR

The Rendering is for Reference only

FARBE COLOR



Reflex Blue | Pearlized Black



Factory Copper | Pearlized Black

**BK28104**

46 | 48 | 51  
54 | 57 | 60

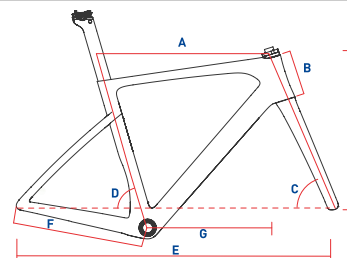

**CCT EVO**

CM	A	B	C	D	E	F	G	H
46	524	101	73	74	966	407	379	504
48	531	112	73	74	974	408	383	515
51	540	130	73	74	984	409	387	532
54	554	149	73	74	997	410	393	550
57	571	173	73	74	1013	411	401	573
60	588	201	73	74	1032	412	411	599

**FEATURES**









# CCT TEAM PRO

Ultraleichter und aerodynamischer „Bumerang Line“ voll Carbon Rahmen.

Ergonomischer Carbon Lenker, so kannst du eine perfekte aerodynamische Position einnehmen.

Shimano Schaltgruppe für flüssige Schaltvorgänge.

Ultralight and aerodynamic «Boomerang Line» full carbon frame.

Ergonomic Carbon handlebar, so you can adopt a perfect aerodynamic position.

Shimano switching group for fluid gear changes.



- CCT Team Disc
- Road Carbon Fork Disc
- Shimano Ultegra 11S
- Shimano Ultegra
- Shimano Ultegra 11S
- Shimano Ultegra 160mm I Front
- Shimano Ultegra 160mm I Rear
- Shimano Ultegra 50 I 34T
- Shimano 105 11-32T 11S
- KMC X11
- Ursus Miura TC37 Disc I Front
- Ursus Miura TC37 Disc I Rear
- Pirelli P7 700 x 26C I Front
- Pirelli P7 700 x 26C I Rear
- Selle Italia Model X
- ZZYX SL Alloy Seatpost 27.2mm
- ZZYX SL Alloy Stem I ICR
- ZZYX SL Alloy Handlebar

The Rendering is for Reference only

**FARBE COLOR**

Reflex Blue | White

**BK28110**

46 | 48 | 51  
54 | 57 | 60

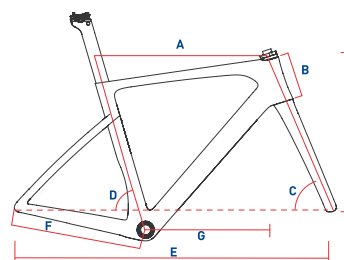

**CCT TEAM DISC**

CM	A	B	C	D	E	F	G	H
46	519	121	71	75	976	407	375	520
48	537	133	73	74	976	407	383	536
51	554	147	73	74	982	407	391	552
54	570	160	73	73	992	407	398	564
57	589	182	73	73	1009	407	408	586
60	604	203	73	73	1025	407	418	606

**FEATURES**





# CCT TEAM ELITE



Ultraleichter und aerodynamischer „Bumerang Line“ voll Carbon Rahmen.

Ergonomischer Carbon Lenker, so kannst du eine perfekte aerodynamische Position einnehmen.

Shimano Schaltgruppe für flüssige Schaltvorgänge.

Ultralight and aerodynamic «Boomerang Line» full carbon frame.

Ergonomic Carbon handlebar, so you can adopt a perfect aerodynamik position.

Shimano switching group for fluid gear changes.



- CCT Team Disc
- Road Carbon Fork Disc
- Shimano 105 11S
- Shimano 105
- Shimano 105 11S
- Shimano 105 160mm | Front
- Shimano 105 160mm | Rear
- Shimano 105 50 | 34T
- Shimano 105 11-32T 11S
- KMC X11
- Mavic Ksyrium S25 Disc | Front
- Mavic Ksyrium S25 Disc | Rear
- Pirelli P7 700 x 26C | Front
- Pirelli P7 700 x 26C | Rear
- Selle Italia Model X
- ZZZZX SL Alloy Seatpost 27.2mm
- ZZZZX SL Alloy Stem | ICR
- ZZZZX SL Alloy Handlebar

The Rendering is for Reference only

FARBE COLOR Silver Rainbow | Gold

## BK28111

46 | 48 | 51  
54 | 57 | 60

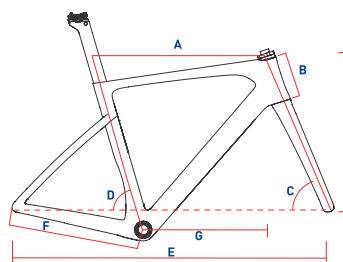

## CCT TEAM DISC

CM	A	B	C	D	E	F	G	H
46	519	121	73	75	976	407	375	520
48	537	113	73	74	977	407	383	536
51	555	147	73	74	982	407	391	552
54	570	160	73	73	992	407	398	564
57	589	182	73	73	1008	407	408	586
60	604	203	73	73	1025	407	418	606

## FEATURES



# CCT TEAM RACE

**CCT TEAM**

Ultraleichter und aerodynamischer „Bumerang Line“ voll Carbon Rahmen.

Ergonomischer Carbon Lenker, so kannst du eine perfekte aerodynamische Position einnehmen.

Shimano Schaltgruppe für flüssige Schaltvorgänge.

Ultralight and aerodynamic «Boomerang Line» full carbon frame.

Ergonomic Carbon handlebar, so you can adopt a perfect aerodynamic position.

Shimano switching group for fluid gear changes.



-  CCT Team Disc
-  Road Carbon Fork Disc
-  Shimano 105 11S
-  Shimano 105
-  Shimano 105 11S
-  Shimano 105 160mm I Front
-  Shimano 105 160mm I Rear
-  Shimano 105 50 I 34T
-  Shimano 105 11-32T 11S
-  KMC X11
-  ZYZX Sport Disc I Front
-  ZYZX Sport Disc I Rear
-  Pirelli P7 700 x 26C I Front
-  Pirelli P7 700 x 26C I Rear
-  Selle Italia Model X
-  ZYZX SL Alloy Seatpost 27.2mm
-  ZYZX SL Alloy Stem I ICR
-  ZYZX SL Alloy Handlebar

The Rendering is for Reference only

**FARBE COLOR**  Race Red | White

**BK28112**

 46 | 48 | 51  
54 | 57 | 60

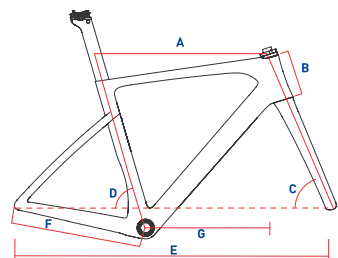

**CCT TEAM DISC**

CM	A	B	C	D	E	F	G	H
46	519	121	71	75	976	407	375	520
48	537	133	73	74	976	407	383	536
51	554	147	73	74	982	407	391	552
54	570	160	73	73	992	407	398	564
57	589	182	73	73	1009	407	408	586
60	604	203	73	73	1025	407	418	606

**FEATURES**







# CORONES EXPERT DISC

**CORONES**

Sportliche Geometrie für eine schnelle Feierabendrunde oder lange Trainingsfahrten.

Herausragende Technologien: PRO CONTROL DISC FORK und PRO SIZE 6 SYSTEM.

Triple Butted Aluminum mit den Vorzügen einer Scheibenbremse.

Sportive geometry for fast afterwork and endurance rides in the same way.

Outstanding technologies: PRO CONTROL DISC FORK and PRO SIZE 6 SYSTEM.

Triple Butted Aluminium frame with all the advantages of a disc brake.



-  Corones Disc
-  Road Carbon Fork Disc
-  Shimano 105 11S
-  Shimano 105
-  Shimano 105 11S
-  Shimano 105 160mm I Front
-  Shimano 105 160mm I Rear
-  Shimano FC-RS510 50 I 34T
-  Shimano 105 11-32T 11S
-  KMC X11
-  ZYZX 700C Disc I Front
-  ZYZX 700C Disc I Rear
-  Pirelli P7 700 x 26C I Front
-  Pirelli P7 700 x 26C I Rear
-  Selle San Marco Monza full fit narrow
-  ZYZX SL Alloy Seatpost 27.2mm
-  ZYZX SL Alloy Stem I ICR
-  ZYZX SL Alloy Handlebar

The Rendering is for Reference only

FARBE COLOR



Pearlized Black | Pearlized White | Red | Green



Pearlized White | Pearlized Black | Red | Green

**BK28120**

46 | 48 | 51  
54 | 57 | 60

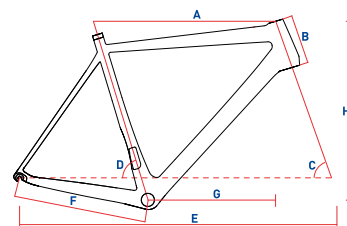

**CORONES EXPERT DISC**

CM	A	B	C	D	E	F	G	H
46	524	108	71	74	976	410	378	510
48	531	118	72	74	976	410	381	522
51	541	135	73	74	987	413	386	539
54	553	152	73	74	997	413	391	555
57	567	173	73	74	1013	416	397	575
60	587	200	73	74	1013	416	397	575

FEATURES





# DOLOMITI ELITE

DOLOMITI

Das Dolomiti verkörpert den Einstieg in die corratec Rennradwelt.

Robuster und leichter Aluminium Rahmen – der ideale Partner für das tägliche Training.



Herausragende Technologien:  
PRO CONTROL FORK und PRO SIZE 6 SYSTEM.

The Dolomiti is perfect device for the first steps into the corratec roadbike family.

Stable and light aluminium frame – fits perfectly for the daily training.

Outstanding technologies:  
PRO CONTROL FORK and PRO SIZE 6 SYSTEM.





-  Dolomiti
-  Road Carbon Fork
-  Shimano 105 11S
-  Shimano 105
-  Shimano 105 11S
-  Tektro R741 Caliper Brake | Front
-  Tektro R741 Caliper Brake | Rear
-  Shimano FC-RS510 50 | 34T
-  Shimano 105 11-32T 11S
-  KMC X11
-  ZZYX 700C Disc | Front
-  ZZYX 700C Disc | Rear
-  Pirelli P7 700 x 26C | Front
-  Pirelli P7 700 x 26C | Rear
-  Selle San Marco Monza full fit narrow
-  ZZYX SL Alloy Seatpost 27.2mm
-  ZZYX SL Alloy Stem
-  ZZYX SL Alloy Handlebar

The Rendering is for Reference only

FARBE COLOR  Pearlized Black | Race Red | White | Grey

**BK28130**

 46 | 48 | 51  
 54 | 57 | 60

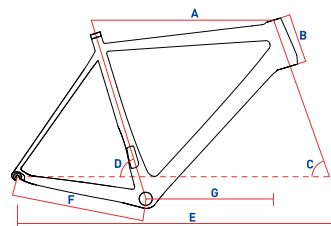

**DOLOMITI ELITE**

CM	A	B	C	D	E	F	G	H
46	505	125	71	74	963	407	360	524
48	522	135	73	74	961	407	367	539
51	530	150	73	74	957	407	365	556
54	547	160	73	73	969	407	374	566
57	572	175	73	73	991	407	392	580
60	588	195	73	73	1007	407	403	599

**FEATURES**



# C:TIME CONFI

**C:TIME**

Das C:Time – Der Sekundenjäger getrimmt auf Geschwindigkeit und Aerodynamik.

Sportliche Geometrie – das perfekte Bike für schnelle und flache Zeitfahren.

















Hochprofil Carbon Laufräder für ein noch besseres Rollverhalten im Kampf gegen die Uhr.

The C: Time – The second hunter trimmed on speed and aerodynamics.

Sportive geometry – the one and only bike for fast and flat time trials.

Aero carbon wheels for an even superior rolling behavior.



-  C:Time SL
-  Carbon Fork included in Frame
-  Sram Red eTAP AXS 12S
-  Sram BLIP
-  TRP T860 Caliper Brake
-  TRP T851 Caliper Brake
-  Sram Red DUB 48T
-  Sram XG1290 D1 10-33T 12S
-  Sram Red D1 12S
-  ZZYX TT Wheelset
-  Continental Grand Prix Attack III 700 x 23C I Front
-  Grand Prix Force III 700 x 25C I Rear
-  Selle San Marco Shortfit Dynamic
-  Seatpost included in Frame
-  ZZYX TT Stem
-  ZZYX TT Handlebar

The Rendering is for Reference only

FARBE COLOR  Blue | White

**BK28140**

 48 | 50 | 52  
54 | 56

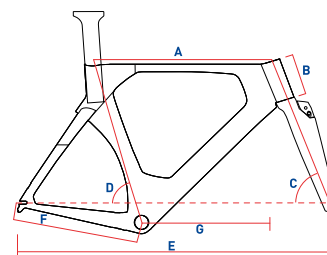

**C:TIME SL**

CM	A	B	C	D	E	F	G	H
48	492	80	73	76	929	387	372	479
50	519	80	73	76	954	387	399	480
52	542	107	73	76	978	387	415	506
54	565	134	73	76	1002	387	431	532
56	587	164	73	76	1027	387	447	558

FEATURES









# THE GRAVELBIKE

Erlebe Dein Abenteuer in jedem Gelände. Raus aus dem Alltag und das einzigartige Feeling der Schotterpisten, Forststraßen oder Radwege genießen. Die corratec Allroad Range ist Dein idealer Begleiter für Deine Offroad Touren. Die speziell abgestimmte Radgeometrie und die verbauten Komponenten eignen sich perfekt für diesen Bereich.

Experience your adventure in any terrain. Get away from everyday life and enjoy the unique feeling of the gravel roads, forest roads or bike paths. The corratec Allroad Range is your companion for your offroad tours. The specially coordinated wheel geometry and the chosen components fits perfectly for this way of biking.

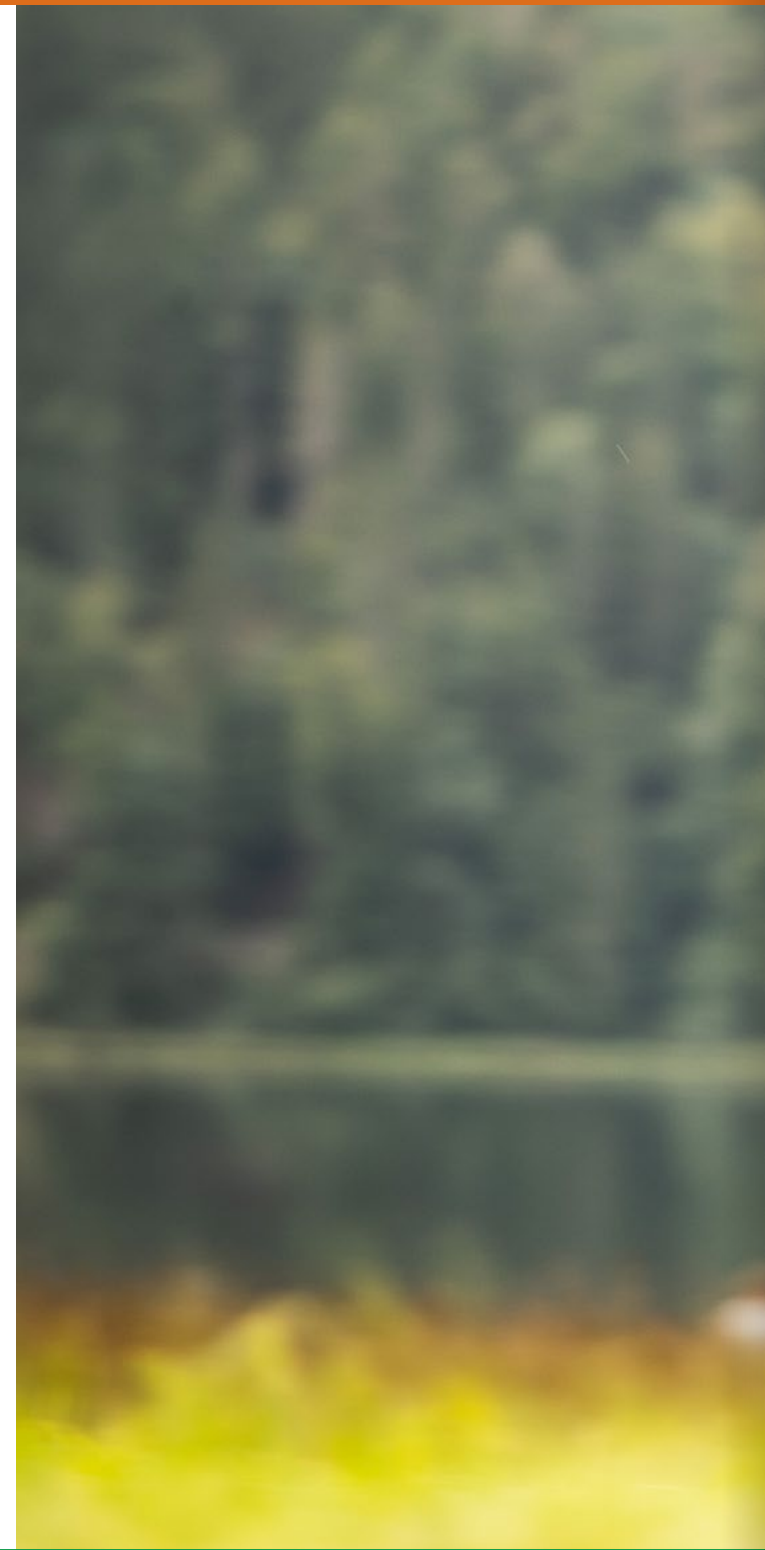







# ALLROAD CARBON

**40**<sub>MM</sub>

Reifenfreiheit  
Tire clearance

---

**12**<sub>speed</sub>

Kettenschaltung  
Chain shifting

---

SHIMANO **GRX**  
**Di2**

interne Kabelführung  
Internal Cable Routing







## LÄNGERER RADSTAND LONGER WHEELBASE

Dank des längeren Radstands und einer größeren Reifenfreiheit können problemlos bis zu 40mm breite Gravel Reifen montiert werden. Mit weniger Luftdruck bietet das Allroad Carbon somit mehr Komfort und erhöhte Pannensicherheit.

Thanks to the longer wheelbase and larger tire clearance, gravel tires up to 40mm wide can be fitted without any problems. With less air pressure, the Allroad Carbon offers more comfort and increased puncture resistance.

## GEPÄCKTRÄGERAUFNAHMEN LUGGAGE CARRIER MOUNTS

Gabel und Hinterbau sind mit Gepäckträgeraufnahmen ausgestattet. Es können somit bequem und zu jederzeit bis zu zwei Gepäckträger montiert werden.

The fork and rear end are equipped with rack mounts. This means that up to two luggage racks can be mounted conveniently and at any time.



## SHIMANO GRX Di2

Die neue gravel Schaltgruppe begeistert mit einer auf Schotter abgestimmten Halterungsergonomie und optimierten Schaltoptionen. Eine durchdachte Lösung für alle, die im Sattel die Welt entdecken möchten.

The all new Gravel groupset impresses with its mounting ergonomics tailored to gravel and optimized gearshift options - a well thought-out solution for everyone who wants to explore the world on two wheels.

# ALLROAD C1

ALLROAD

Gepäckträgeraufnahmen an Gabel und Hinterbau, um schnell für das große Abenteuer aufzurüsten.

Perfekt als Commuter für tägliche Pendelfahrten wie zur Arbeit.







Rahmen mit Endurance Geometrie und sportlichem schlanken Design.

Luggage Carrier on the fork and at the rear to be ready at all time for a huge adventure.

Fits perfectly as a commuter for daily rides.

Endurance Geometry with a sportive aerodynamic design.



-  Allroad Carbon
-  Allroad Carbon Fork
-  Shimano GRX Di2 11S
-  Shimano GRX Di2 11S
-  Shimano GRX 160mm I Front
-  Shimano GRX 160mm I Rear
-  Shimano GRX 42T
-  Shimano Deore XT 11-42T 11S
-  KMC X11
-  Mavic Allroad S Disc I Front
-  Mavic Allroad S Disc I Rear
-  WTB Riddler 700 x 45 I Front
-  WTB Riddler 700 x 45 I Rear
-  Selle Italia Model X
-  Seatpost included in Frame
-  ZZYZX SL Alloy Stem
-  ZZYZX Carbon Handlebar

The Rendering is for Reference only

FARBE COLOR  Cool Gray | Dark Red | Slate Gray

## BK28160

 47 | 49 | 52  
54 | 56 | 58

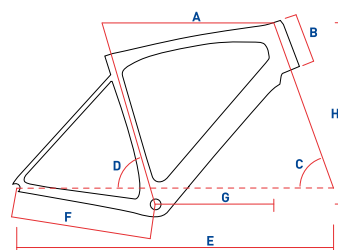

## ALLROAD CARBON

CM	A	B	C	D	E	F	G	H
47	495	95	70	75	1014	440	356	522
49	505	111	70	74	1014	440	365	537
52	526	136	70	74	1032	440	365	561
54	546	156	71	73	1038	440	373	584
56	570	176	71	73	1058	440	385	602
58	591	196	71	73	1079	440	401	621

## FEATURES





# ALLROAD C2

# ALLROAD

Gepäckträgeraufnahmen an Gabel und Hinterbau, um schnell für das große Abenteuer aufzurüsten.

Perfekt als Commuter für tägliche Pendelfahrten wie zur Arbeit.

















Rahmen mit Endurance Geometrie und sportlichem schlanken Design.

Luggage Carrier on the fork and at the rear to be ready at all time for a huge adventure.

Fits perfectly as a commuter for daily rides.

Endurance Geometry with a sportive aerodynamic design.



-  Allroad Carbon
-  Allroad Carbon Fork
-  Shimano GRX 11S
-  Shimano GRX 11S
-  Shimano GRX 160mm I Front
-  Shimano GRX 160mm I Rear
-  Shimano GRX 48 I 31T
-  Shimano CS-HG70011 11-34T 11S
-  KMC X11
-  ZYZX 700C Disc I Front
-  ZYZX 700C Disc I Rear
-  WTB Riddler 700 x 45 I Front
-  WTB Riddler 700 x 45 I Rear
-  Selle Italia Model X
-  Seatpost included in Frame
-  ZYZX SL Alloy Stem
-  ZYZX SL Alloy Handlebar

The Rendering is for Reference only

FARBE COLOR  Gray Blue | Tropical Yellow | Cool Gray

## BK28161

47 | 49 | 52  
54 | 56 | 58

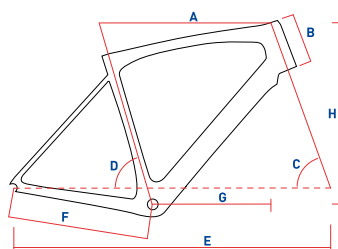

## ALLROAD CARBON

CM	A	B	C	D	E	F	G	H
47	495	95	70	75	1014	440	356	522
49	505	111	70	74	1014	440	365	537
52	526	136	70	74	1032	440	365	561
54	546	156	71	73	1038	440	373	584
56	570	176	71	73	1058	440	385	602
58	591	196	71	73	1079	440	401	621

## FEATURES



# ALLROAD A1

ALLROAD

Ein absoluter Eyecatcher auf allen Offroadpisten oder als urbanes Transportmittel.

Die speziell vormontierten Gepäckträgeraufnahmen stellen Dir ausreichend Platz für Packtaschen zur Verfügung.

Die kompakte Rahmengeometrie schafft maximale Wendigkeit im Gelände.

With the new face lift jealous views are granted at worlds most spectacular gravel roads.

Luggage carrier mounts at the front and at the rear – be prepared for the huge adventure.

Fits perfectly for commuting or as daily training device especially in spring and autumn.



-  Allroad
-  Allroad Carbon Fork
-  Shimano GRX 11S
-  Shimano GRX 11S
-  Shimano GRX 160mm I Front
-  Shimano GRX 160mm I Rear
-  Shimano GRX 40T
-  Shimano SLX 11-42T 11S
-  KMC X11
-  ZZYX 700C Disc I Front
-  ZZYX 700C Disc I Rear
-  Schwalbe G-One Allroad 40-622 I Front
-  Schwalbe G-One Allroad 40-622 I Rear
-  Selle San Marco Monza full fit narrow
-  ZZYX SL Alloy Seatpost 27.2mm
-  ZZYX SL Alloy Stem
-  ZZYX SL Alloy Handlebar

The Rendering is for Reference only

FARBE COLOR  Dark Anthracite | Orange Yellow | light Blue

## BK28170

 46 | 49 | 52  
55 | 58 | 61

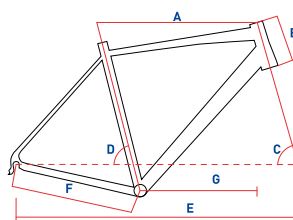

## ALLROAD

CM	A	B	C	D	E	F	G	H
46	525	115	70	74	1012	430	372	535
49	531	124	71	74	1013	430	375	546
52	540	138	71	74	1023	430	380	559
55	551	155	71	74	1035	430	386	575
58	572	180	71	73	1052	430	395	599
61	596	210	71	73	1072	430	405	627

## FEATURES





# ALLROAD A2

# ALLROAD

Ein absoluter Eyecatcher auf allen Offroadpisten oder als urbanes Transportmittel.

Die speziell vormontierten Gepäckträgeraufnahmen stellen Dir ausreichend Platz für Packtaschen zur Verfügung.

Die kompakte Rahmengeometrie schafft maximale Wendigkeit im Gelände.

With the new face lift jealous views are granted at worlds most spectacular gravel roads.

Luggage carrier mounts at the front and at the rear – be prepared for the huge adventure.

Fits perfectly for commuting or as daily training device especially in spring and autumn.



- Allroad
- Allroad Carbon Fork
- Shimano Tiagra 10S
- Shimano Tiagra 10S
- Tektro Spyre 160mm I Front
- Tektro Spyre 160mm I Rear
- Shimano FC-R460 46 I 34T
- Shimano CS-HG50 11-32T 10S
- KMC X10
- ZZYZX 700C Disc I Front
- ZZYZX 700C Disc I Rear
- Schwalbe G-One Allroad 40-622 I Front
- Schwalbe G-One Allroad 40-622 I Rear
- Selle San Marco Monza full fit narrow
- ZZYZX SL Alloy Seatpost 27.2mm
- ZZYZX SL Alloy Stem
- ZZYZX SL Alloy Handlebar

The Rendering is for Reference only

FARBE COLOR Petrol Blue | Light Blue | Green

**BK28171**

46 | 49 | 52  
55 | 58 | 61

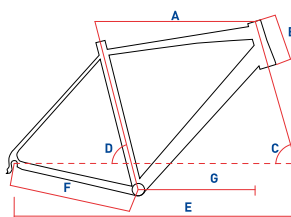

**ALLROAD**

CM	A	B	C	D	E	F	G	H
46	525	115	70	74	1012	430	372	535
49	531	124	71	74	1013	430	375	546
52	540	138	71	74	1023	430	380	559
55	551	155	71	74	1035	430	386	575
58	572	180	71	73	1052	430	395	599
61	596	210	71	73	1072	430	405	627

**FEATURES**



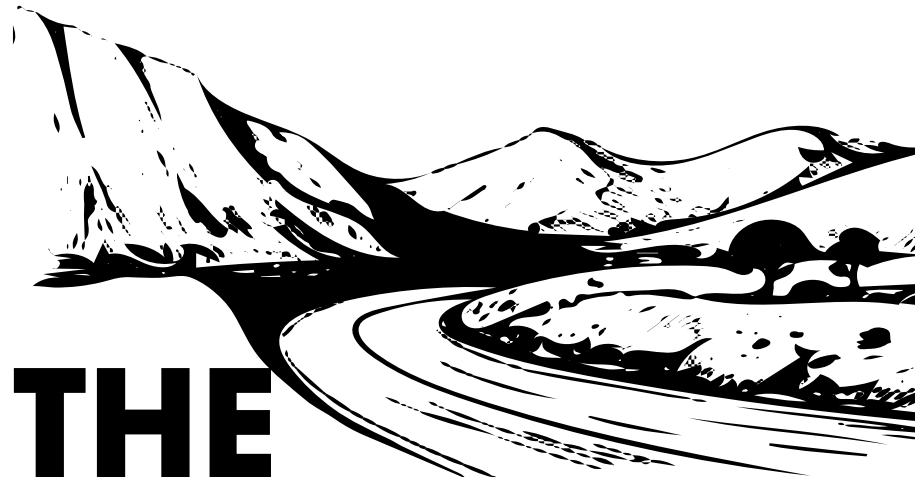

# THE TRAVELBIKE

Erlebe Dein Abenteuer in jedem Gelände. Raus aus dem Alltag und das einzigartige Feeling der Schotterpisten, Forststraßen oder Radwege genießen. Die corratec Allroad Range ist Dein idealer Begleiter für Deine Offroad Touren. Die speziell abgestimmte Radgeometrie und die verbauten Komponenten eignen sich perfekt für diesen Bereich.

Experience your adventure in any terrain. Get away from everyday life and enjoy the unique feeling of the gravel roads, forest roads or bike paths. The corratec Allroad Range is your companion for your offroad tours. The specially coordinated wheel geometry and the chosen components fits perfectly for this way of biking.









# ALLROAD TRAVEL



# 40<sub>MM</sub>

Reifenfreiheit  
Tire clearance

---

# 12<sub>speed</sub>

Kettenschaltung  
Chain shifting

---

# BOW SITZSTREBE

Für maximalen Komfort  
For maximum comfort





## LÄNGERER RADSTAND LONGER WHEELBASE

Dank des längeren Radstands und einer größeren Reifenfreiheit können problemlos bis zu 40mm breite Gravel Reifen montiert werden. Mit weniger Luftdruck bietet das Allroad Carbon somit mehr Komfort und erhöhte Pannensicherheit.

Thanks to the longer wheelbase and larger tire clearance, gravel tires up to 40mm wide can be fitted without any problems. With less air pressure, the Allroad Carbon offers more comfort and increased puncture resistance.

## GEPÄCKTRÄGERAUFNAHMEN LUGGAGE CARRIER MOUNTS

Gabel und Hinterbau sind mit Gepäckträgeraufnahmen ausgestattet. Es können somit bequem und zu jederzeit bis zu zwei Gepäckträger montiert werden.

The fork and rear end are equipped with rack mounts. This means that up to two luggage racks can be mounted conveniently and at any time.



## SHIMANO GRX

Die neue gravel Schaltgruppe begeistert mit einer auf Schotter abgestimmten Halterungsergonomie und optimierten Schaltoptionen. Eine durchdachte Lösung für alle, die im Sattel die Welt entdecken möchten.

The all new Gravel groupset impresses with its mounting ergonomics tailored to gravel and optimized gearshift options - a well thought-out solution for everyone who wants to explore the world on two wheels.

# ALLROAD TRAVEL 1

ALLROAD

Das sehr stabile Allroad ist der ideale Partner für Deine Bikepacking Touren und Expeditionen.

Die speziell vormontierten Gepäckträgeraufnahmen stellen Dir ausreichend Platz für Packtaschen zur Verfügung.

Der stabile Alurahmen bietet Dir ausreichend Sicherheit im Gelände.

The very stable Allroad is your perfect partner for your bikepacking tours and expeditions.

The specially pre-assembled luggage rack mounts provide you with sufficient space for panniers.

The stable aluminum frame offers you sufficient safety in the field.



-  Allroad Travel
-  Allroad Alloy Fork
-  Shimano GRX 10S
-  Shimano GRX 10S
-  Shimano GRX 160mm I Front
-  Shimano GRX 160mm I Rear
-  Shimano GRX 46 I 30T
-  Shimano CS-HG50 11-36T 10S
-  KMC X10
-  ZYZX 700C Disc I Front
-  ZYZX 700C Disc I Rear
-  Schwalbe G-One Bite Perf. 50-622 I Front
-  Schwalbe G-One Bite Perf. 50-622 I Rear
-  Selle Italia X3
-  ZYZX Suspension Seatpost 27.2mm
-  Redshift Shockstop suspension stem
-  ZYZX Gravel Riser

The Rendering is for Reference only

FARBE COLOR

 Orange Red | Pearlized Black | Dark Red

**BK28180**

 46 | 49 | 52  
55 | 58 | 61

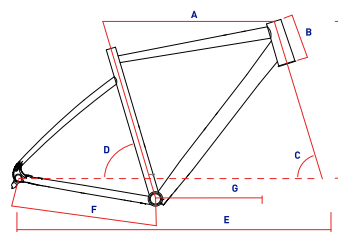

**ALLROAD TRAVEL**

CM	A	B	C	D	E	F	G	H
46	542	115	71	74	1057	460	382	557
49	551	129	71	74	1062	460	387	572
52	561	145	71	74	1072	460	392	588
55	570	161	71	74	1082	460	397	603
58	579	178	71	74	1093	460	402	619
61	589	194	71	74	1103	460	407	635

**FEATURES**





# ALLROAD TRAVEL 2

ALLROAD

Das sehr stabile Allroad ist der ideale Partner für Deine Bikepacking Touren und Expeditionen.

Die speziell vormontierten Gepäckträgeraufnahmen stellen Dir ausreichend Platz für Packtaschen zur Verfügung.

Der stabile Alurahmen bietet Dir ausreichend Sicherheit im Gelände.

The very stable Allroad is your perfect partner for your bikepacking tours and expeditions.

The specially pre-assembled luggage rack mounts provide you with sufficient space for panniers.

The stable aluminum frame offers you sufficient safety in the field.



- Allroad Travel
- Allroad Alloy Fork
- Shimano Claris 8S
- Shimano Claris 8S
- Tektro Spyre 160mm I Front
- Tektro Spyre 160mm I Rear
- Shimano Claris 50 I 34T
- Shimano CS-HG50 11-34T 8S
- KMC X8
- ZZYZX 700C Disc I Front
- ZZYZX 700C Disc I Rear
- Schwalbe G-One Bite Perf. 50-622 I Front
- Schwalbe G-One Bite Perf. 50-622 I Rear
- Selle Italia X3
- ZZYZX Suspension Seatpost 27.2mm
- Redshift Shockstop suspension stem
- ZZYZX Gravel Riser

The Rendering is for Reference only

**FARBE COLOR** Lime Green | Anthracite | Dark Green

**BK28181**

46 | 49 | 52  
55 | 58 | 61

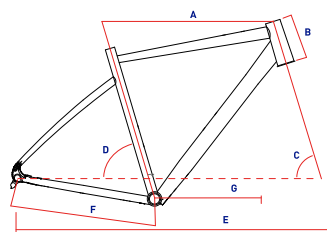

**ALLROAD TRAVEL**

CM	A	B	C	D	E	F	G	H
46	542	115	71	74	1057	460	382	557
49	551	129	71	74	1062	460	387	572
52	561	145	71	74	1072	460	392	588
55	570	161	71	74	1082	460	397	603
58	579	178	71	74	1093	460	402	619
61	589	194	71	74	1103	460	407	635

**FEATURES**





# THE MOUNTAINBIKE

Unsere Mountainbikes sind auf den Straßen, im Gelände und am Berg zu Hause – und das mit großem Erfolg. Die Herausforderung für uns ist es, den Ansprüchen an Design und Technik gerecht zu werden! Seit Jahrzehnten arbeiten wir an dem perfekten Mountainbike, denn für jeden gibt es das perfekte Fahrrad! Für Simon Gegenheimer ist es das Revo Bow.

Our mountain bikes perform on the roads, off-road and on the mountain – and this with great success. The main challenge for us is to satisfy the demands of design and technology – since day one! We have been working on the perfect mountain bike for world-class level for decades, because for everyone there is the perfect bike! For Simon Gegenheimer it is the Revo Bow.









# REVONBOW SL FACTORY



2021 MOUNTAIN BIKE ELIMINATOR  
WORLD CHAMPIONSHIPS

GRAZ  
AUSTRIA

# 948<sup>GR</sup>

RAHMENGEWICHT  
FRAMEWEIGHT

# AXS 12S

Kabelloses Schalten  
Wireless shifting

# 100<sup>MM</sup>

Rockshox SID Ultimate Gabel  
Rockshox SID Ultimate Fork

AKTUELLES WELTMEISTER-RAD 2022  
VON SIMON GEGENHEIMER  
CURRENT WORLD CHAMPION BIKE 2022  
BY SIMON GEGENHEIMER







## MAXIMALE KRAFTÜBERTRAGUNG MAXIMUM POWER TRANSMISSION

Die Rahmenform „Bow“ wird zu 100% im Hause corrateg konstruiert und entwickelt. Diese Rahmenform bietet Dir maximale Verwindungssteifigkeit und erzeugt größtmögliche Traktion und Kontrolle in jedem Gelände.

This unique innovation, 100% designed and developed by corrateg, offers you maximum torsional rigidity of the frame and thus generates the greatest possible traction and control in any terrain.

## VERTIKALER FLEX VERTICAL FLEX

Eine weitere herausragende Innovation von corrateg ist das neuentwickelte Sattelrohr des Revo Bow. Diese Weiterentwicklung bietet Dir durch seine breitere Form ein neues Maß an Dämpfungseigenschaften.

Another outstanding innovation from corrateg is the newly developed seat tube of the Revo Bow. This further development offers you a new level of damping properties thanks to its wider shape.



## EINZIGARTIGES DESIGN UNIQUE DESIGN

Das Design des neuen Revo Bow ist ein absolutes Highlight. Diese besondere Perlmutt-Lackierung garantiert maximale Aufmerksamkeit während der Fahrt und auf der Alm.

The design of the new Revo Bow is an absolute highlight. With its different color effects, this extravagant mother-of-pearl finish ensures you maximum attention during your ride and on the alpine pasture.

# REVO BOW SL FACTORY

# REVO BOW

Das einzigartige Bow Design überzeugt mit einem höchsten Maß an Torsionssteifigkeit für maximale Kontrolle.

Die innenverlegten Züge sorgen für eine cleane Optik des Rads.

Technisch rundet die elektronische Schaltung Sram Eagle AXS das komplette System ab.

The unique bow design impresses with a high degree of torsional rigidity for maximum control.

Internal Cable Routing give the bike a clean look.

Technically, the Sram Eagle AXS electronic gearshift rounds off the entire system.



- Revo Bow SL
- Rockshox SID SL Ultimate Remote 29" 100mm
- Sram XX1 Eagle AXS 12S
- Sram AXS Eagle 12S
- Sram Level Ultimate Carbon 180mm
- Sram Level Ultimate Carbon 160mm
- Sram XX1 Eagle DUB 175mm 32T
- Sram XG1299 Eagle 10-52T 12S
- Sram XX1 Eagle Rainbow 12S
- DT Swiss XRC 1200 Spline 29" Tubeless Ready I Front
- DT Swiss XRC 1200 Spline 29" Tubeless Ready I Rear
- Schwalbe Racing Ray 57-622 I Front
- Schwalbe Racing Ralph 57-622 I Rear
- Selle Italia Flite Boost Superflow Carbon
- ZZYX Carbon Seatpost 31.6mm
- ZZYX SL Alloy Stem
- ZZYX SL Carbon Handlebar

The Rendering is for Reference only

FARBE COLOR Pitch Black | Factory Copper | Silver

**BK28010**

39 | 44 | 49 | 54

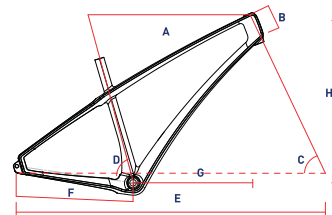

**REVO BOW SL**

CM	A	B	C	D	E	F	G	H
39	580	95	69	72	1090	425	406	605
44	600	100	69	72	1111	425	425	610
49	625	110	69	72	1136	425	447	619
54	650	121	69	72	1162	425	468	629

**FEATURES**









# REVO BOW SL PRO TEAM

# REVO BOW

Einzigartiges Bow Design sorgt für einen ausserordentlich steifen und gleichzeitig superleichten Rahmen.

Aufgeräumtes Cockpit mit komplett innenverlegten Zügen - Internal Cable Routing.

Der edle Carbon Rahmen bietet beste Dämpfungseigenschaften auf langen Tagestouren.

The new Bow Hardtail, extremely stiff and at the same time superlight.

Tidy cockpit with completely internal cables.

The noble carbon frame offers the best damping properties on long day trips.



- Revo Bow SL
- Rockshox SID SL Select+ RL Remote 29" 100mm
- Sram X01 Eagle 12S
- Sram X01 Eagle 12S
- Sram G2 180mm | Front
- Sram G2 160mm | Rear
- Sram X01 Eagle DUB 175mm 32T
- Sram XG1295 Eagle 10-52T 12S
- Sram NX Eagle 12S
- DT Swiss XMC 1501 Spline 29" Tubeless Ready | Front
- DT Swiss XMC 1501 Spline 29" Tubeless Ready | Rear
- Schwalbe Racing Ray 57-622 | Front
- Schwalbe Racing Ralph 57-622 | Rear
- Selle Italia Flite Boost Superflow Manganese
- ZZYX Carbon Seatpost 31.6mm
- ZZYX SL Alloy Stem
- ZZYX SL Carbon Handlebar

The Rendering is for Reference only

FARBE COLOR Reflex Blue | Pitch Black | White

**BK28011**

39 | 44 | 49 | 54

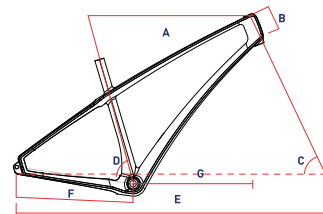

**REVO BOW SL**

CM	A	B	C	D	E	F	G	H
39	580	95	69	72	1090	425	406	605
44	600	100	69	72	1111	425	425	610
49	625	110	69	72	1136	425	447	619
54	650	121	69	72	1162	425	468	629

**FEATURES**





# REVO BOW SL PRO

Einzigartiges Bow Design sorgt für einen ausserordentlich steifen und gleichzeitig superleichten Rahmen.

















Aufgeräumtes Cockpit mit komplett innenverlegten Zügen - Internal Cable Routing.

Der edle Carbon Rahmen bietet beste Dämpfungseigenschaften auf langen Tagestouren.

The new Bow Hardtail, extremely stiff and at the same time superlight.

Tidy cockpit with completely internal cables.

The noble carbon frame offers the best damping properties on long day trips.

-  Revo Bow SL
-  Rockshox SID SL Select Remote 29" 100mm
-  Shimano Deore XT SGS 12S
-  Shimano SLX 12S
-  Shimano SLX BR-M7120 180mm I Front
-  Shimano SLX BR-M7100 160mm I Rear
-  Shimano SLX 175mm 32T
-  Shimano SLX 10-51T 12S
-  KMC X12
-  DT Swiss M 1900 Spline 29" Tubeless Ready I Front
-  DT Swiss M 1900 Spline 29" Tubeless Ready I Rear
-  Schwalbe Racing Ray 57-622 I Front
-  Schwalbe Racing Ralph 57-622 I Rear
-  Selle Italia Model X
-  ZZYX Carbon Seatpost 31.6mm
-  ZZYX SL Alloy Stem
-  ZZYX SL Carbon Handlebar



The Rendering is for Reference only

FARBE COLOR

Reflex Blue |  Pitch Black |  White

**BK28012**

 39 | 44 | 49 | 54

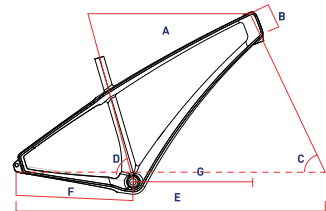

**REVO BOW SL**

CM	A	B	C	D	E	F	G	H
<b>39</b>	580	95	69	72	1090	425	406	605
<b>44</b>	600	100	69	72	1111	425	425	610
<b>49</b>	625	110	69	72	1136	425	447	619
<b>54</b>	650	121	69	72	1162	425	468	629

**FEATURES**



# REVO BOW ELITE

Das Rad dient als bestes Trainingsgerät auf XCO Strecken und ist mit hochwertigen Komponenten ausgestattet.

















Der eingesetzte EPS Carbon Rahmen besitzt ein hohes Maß an Steifigkeit.

Das speziell geformte Oberrohr garantiert mehr Sicherheit und Fahrspaß in anspruchsvollem Gelände.

The bike serves as the best training device on XCO routes and is equipped with high-quality comp nents.

Extremely stiff thanks to an EPS carbon made frame.

Arched top tube for increasing safety and comfort on technically trails.

-  Revo Bow
-  Rockshox SID Select Remote 29" 100mm
-  Sram GX Eagle 12S
-  Sram GX Eagle 12S
-  Sram Level T 180mm I Front
-  Sram Level T 160mm I Rear
-  Sram GX Eagle DUB
-  Sram PG1230 Eagle 11-50T 12S
-  Sram SX Eagle 12S
-  Mavic Crossmax 29" I Front
-  Mavic Crossmax 29" I Rear
-  Schwalbe Nobby Nic 29" x 2.25 I Front
-  Schwalbe Nobby Nic 29" x 2.25 I Rear
-  Selle Italia Model X
-  ZZYX SL Alloy Seatpost 31.6mm
-  ZZYX SL Alloy Stem
-  ZZYX SL Alloy Handlebar



# REVO BOW

The Rendering is for Reference only

FARBE COLOR  Petrol I Orange Red

**BK28013**

 39 | 44 | 49 | 54

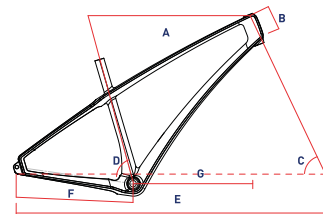

**REVO BOW**

CM	A	B	C	D	E	F	G	H
39	580	95	69	72	1090	425	406	605
44	600	100	69	72	1111	425	425	610
49	625	110	69	72	1136	425	447	619
54	650	121	69	72	1162	425	468	629

**FEATURES**





# REVO BOW

# REVO BOW

Das Rad dient als bestes Trainingsgerät auf XCO Strecken und ist mit hochwertigen Komponenten ausgestattet.

Der eingesetzte EPS Carbon Rahmen besitzt ein hohes Maß an Steifigkeit.

Das speziell geformte Oberrohr garantiert mehr Sicherheit und Fahrspaß in anspruchsvollem Gelände.

The bike serves as the best training device on XCO routes and is equipped with high-quality components.

Super stiff and light EPS carbon frame.

Arched top tube for increasing safety and comfort on technically trails.



- Revo Bow
- Manitou Markhor 29" 100mm
- Sram SX Eagle 12S
- Sram SX Eagle 12S
- Sram Level T 180mm | Front
- Sram Level T 160mm | Rear
- Sram SX Eagle DUB 175mm 32T
- Sram PG1210 Eagle 11-50T 12S
- Sram SX Eagle 12S
- ZZYX Cross Attack 29" | Rear
- ZZYX Cross Attack 29" | Front
- Schwalbe Nobby Nic 29" x 2.26 | Front
- Schwalbe Nobby Nic 29" x 2.26 | Rear
- Selle Italia Model X
- ZZYX SL Alloy Seatpost 31.6mm
- ZZYX SL Alloy Stem
- ZZYX SL Alloy Handlebar

The Rendering is for Reference only

FARBE COLOR

Space Green | Sea Blue

**BK28014**

39 | 44 | 49 | 54

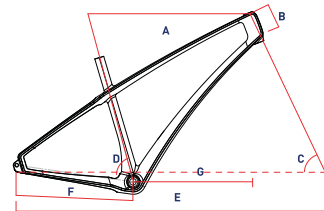

**REVO BOW**

CM	A	B	C	D	E	F	G	H
39	580	95	69	72	1090	425	406	605
44	600	100	69	72	1111	425	425	610
49	625	110	69	72	1136	425	447	619
54	650	121	69	72	1162	425	468	629

**FEATURES**





# REVOLUTION iLINK SL FACTORY



# 2000<sub>GR</sub>

Rahmengewicht inkl.  
Dämpfer  
Frame weight incl. Damper

# 520%

Übersetzungsbandbreite  
Transmission bandwidth

# 100<sub>MM</sub>

Rockshox SID Ultimate Gabel  
Rockshox SID Ultimate Fork





## VIRTUELLER DREHPUNKT VIRTUAL PIVOT POINT

Aufgrund der speziellen Rahmengeometrie und der Anordnung der Dämpfungseinheit verlagert sich der virtuelle Drehpunkt oberhalb der Kettenstrebe.

**Automatischer Lockout - Maximaler Vortrieb - Bessere Traktion**

Due to the special frame geometry or the arrangement of the damper unit the virtual pivot point shifts slightly above the chainstay.

**Automatic lockout - Maximum traction - Increasing propulsion**

## 200% ANTI SQUAD VERTICAL FLEX

Bei Kettenspannung und offenem Dämpfer entsteht dabei ein 200% Anti Squad, der Dämpfer zieht sich bis zum Anschlag auseinander und das Hinterrad wird automatisch nach unten in den Boden gedrückt.

Chain tension and an open damper creates a 200% Anti Squad, the damper pulls apart until stop and the rear wheel will automatically pressed down into the ground.



## AUTOMATISCHER LOCKOUT AUTOMATIC LOCKOUT

Das iLink System kann ganz ohne Lockout (ohne Sperrung des Dämpfers) gefahren werden. Ganz nach dem Motto: „Konzentriere Dich aufs Fahren und vergiss den Lockout!“

The iLink System can be cycled without any lockout (no locking of the damper). „Forget the lockout, keep your eyes on the trail!“



# REVOLUTION iLINK SL FACTORY

Superlight Rahmen mit einem Gewicht inkl. Dämpfer unter 2000gr und einer sehr hohen Torsionssteifigkeit.

Die verbaute iLink Technologie strafft den Hinterbau ganz ohne Lockout und erzielt maximalen Vortrieb im Gelände.

Hochwertige Komponenten garantieren Dir beste Performance auf allen Trails.

Superlight frame with a weight including damper under 2000gr and a very high torsional stiffness.

iLink TECHNOLOGY – the rear triangle without a separate lockout achieves maximum propulsion.

High-quality components ensures best performance on all trails.



- Revolution iLink SL
- Rockshox SID Ultimate Remote 29" 100mm
- Rockshox SID Luxe Ultimate RL 190 x 40
- Sram XX1 Eagle AXS 12S
- Sram AXS Eagle 12S
- Sram Level Ultimate Carbon 180mm I Front
- Sram Level Ultimate Carbon 160mm I Rear
- Sram XX1 Eagle DUB 175mm 32T
- Sram XG1299 Eagle 10-52T 12S
- Sram XX1 Eagle Rainbow 12S
- DT Swiss XRC 1200 Spline 29" I Front
- DT Swiss XRC 1200 Spline 29" I Rear
- Schwalbe Racing Ray 60-622 I Front
- Schwalbe Racing Ralph 60-622 I Rear
- Selle Italia Flite Boost Superflow Carbon
- Rockshox Reverb AXS 31.6mm
- ZZYX SL Alloy Stem
- ZZYX SL Carbon Handlebar

The Rendering is for Reference only

FARBE COLOR Factory Copper I Pearlized Black

**BK28000**

44 | 48 | 52

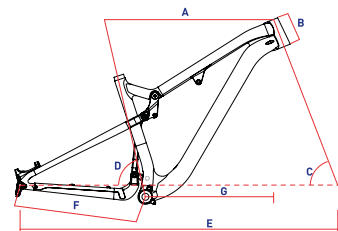

**REVOLUTION iLINK SL**

CM	A	B	C	D	E	F	G	H
44	586	101	69	75	1136	435	444	603
48	612	108	69	75	1163	435	469	609
52	628	124	69	75	1181	435	484	624

**FEATURES**





# REVOLUTION iLINK SL PRO TEAM

120mm Federweg für mehr Fahrspaß auf anspruchsvollem Gelände.

Die verbaute iLink Technologie strafft den Hinterbau ganz ohne Lockout und erzielt maximalen Vortrieb im Gelände.

Flacher Lenkwinkel für mehr Komfort auf langen Allmountain Touren und Alpenüberquerungen.

120mm suspension travel for superior riding pleasure on technically trails.

iLink TECHNOLOGY – the rear triangle without a separate lockout achieves maximum propulsion.

Flatter steering head angle ensures more comfort on Allmountain tours.

- ✓ Revolution iLink SL
- 🔧 Rockshox SID Select+ RL Remote 29" 120mm
- 🔧 Rockshox Deluxe Select+ RT 190 x 45
- 🔧 Sram X01 Eagle 12S
- 🔧 Sram GX Eagle 12S
- 🔧 Sram G2 180mm I Front
- 🔧 Sram G2 160mm I Rear
- 🔧 Sram X1 Eagle DUB 175mm 32T
- 🔧 Sram XG1295 Eagle 10-52T 12S
- 🔧 Sram GX Eagle 12S Grey
- 🔧 DT Swiss XM 1700 Spline 29" I Front
- 🔧 DT Swiss XM 1700 Spline 29" I Rear
- 🔧 Schwalbe Racing Ray 60-622 I Front
- 🔧 Schwalbe Racing Ralph 60-622 I Rear
- 🔧 Selle Italia Flite Boost Superflow Manganese
- 🔧 Kindshock LEV Integra 31.6mm
- 🔧 ZZYX SL Alloy Stem
- 🔧 ZZYX SL Carbon Handlebar



The Rendering is for Reference only

**FARBE COLOR** ● Factory Copper I Pearlized Black

**BK28001**

👤 44 | 48 | 52

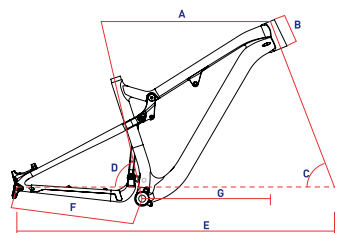

**REVOLUTION iLINK SL**

CM	A	B	C	D	E	F	G	H
44	586	101	69	75	1136	435	444	603
48	612	108	69	75	1163	435	469	609
52	628	124	69	75	1181	435	484	624

**FEATURES**



# REVOLUTION iLINK PRO



Das ideale Rad für Allmountain Touren und flowige Trails.

Die verbaute iLink Technologie strafft den Hinterbau ganz ohne Lockout und erzielt maximalen Vortrieb im Gelände.

Das nach Boost Standard entwickelte Rad erzeugt maximale Agilität im Gelände.

The perfect bike for allmountain tours and flowy trails.

iLink TECHNOLOGY – the rear triangle without a separate lockout achieves maximum propulsion.

The bike, developed according to the Boost standard, generates maximum agility offroad.



- Revolution iLink
- Rockshox SID Select RL 29" 120mm
- Rockshox Deluxe Select+ RT 190 x 45
- Shimano Deore XT SGS 12S
- Shimano Deore XT 12S
- Shimano Deore XT M8120 180mm I Front
- Shimano Deore XT M8100 160mm I Rear
- Shimano Deore XT 175mm 32T
- Shimano SLX 10-51T 12S
- KMC X12
- DT Swiss M 1900 Spline 29" Tubeless Ready I Front
- DT Swiss M 1900 Spline 29" Tubeless Ready I Rear
- Schwalbe Hans Dampf 60-622 I Front
- Schwalbe Hans Dampf 60-622 I Rear
- Selle Italia Model X
- Kindshock Ragei 31.6mm
- ZZZYZX SL Alloy Stem
- ZZZYZX SL Alloy Handlebar

The Rendering is for Reference only

FARBE COLOR Pearlized Black | Rainbow Silver | Gold

**BK28002**

44 | 48 | 52

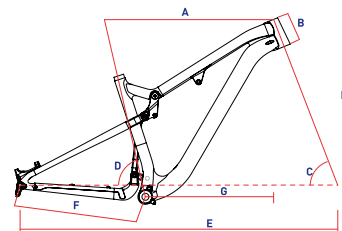

## REVOLUTION iLINK

CM	A	B	C	D	E	F	G	H
44	586	101	69	75	1136	435	444	603
48	612	108	69	75	1163	435	469	609
52	628	124	69	75	1181	435	484	624

## FEATURES





# REVOLUTION iLINK ELITE



Das ideale Rad für Allmountain Touren und flowige Trails.

Die verbaute iLink Technologie strafft den Hinterbau ganz ohne Lockout und erzielt maximalen Vortrieb im Gelände.

Das nach Boost Standard entwickelte Rad erzeugt maximale Agilität im Gelände.

The perfect bike for allmountain tours and flowy trails.

iLink TECHNOLOGY – the rear triangle without a separate lockout achieves maximum propulsion.

The bike, developed according to the Boost standard, generates maximum agility off-road.



- Revolution iLink
- Rockshox Reba RL 29" 120mm
- Rockshox Deluxe Select+ RT 190 x 45
- Sram NX Eagle 12S
- Sram NX Eagle 12S
- Sram Guide T 180mm I Front
- Sram Guide T 160mm I Rear
- Sram NX Eagle DUB 175mm 32T
- Sram PG1210 Eagle 11-50T 12S
- Sram SX Eagle 12S
- Mavic Crossmax 29" I Front
- Mavic Crossmax 29" I Rear
- Schwalbe Hans Dampf 60-622 I Front
- Schwalbe Hans Dampf 60-622 I Rear
- Selle Italia Model X
- Kindshock E20i 31.6mm
- ZZYZX SL Alloy Stem
- ZZYZX SL Alloy Handlebar

The Rendering is for Reference only

FARBE COLOR Racing Red I Pearlized Black I Anodized White

**BK28003**

44 | 48 | 52

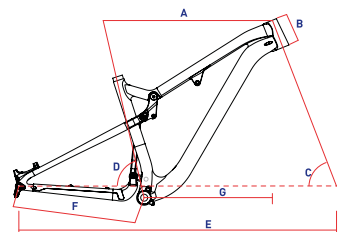

**REVOLUTION iLINK**

CM	A	B	C	D	E	F	G	H
44	586	101	69	75	1136	435	444	603
48	612	108	69	75	1163	435	469	609
52	628	124	69	75	1181	435	484	624

**FEATURES**



# X VERT PRO TEAM

Unser Highlight der corratec Hardtail Einstiegsmodelle.

Der aus hochwertigem Triple Butted Aluminium gefertigte Rahmen besticht durch sein leichtes Gewicht und hohen Steifigkeitswerte.

Die sehr ansprechende Optik verleiht dem Rad einen exklusiven Charakter.

Our highlight of the corratec hardtail entry-level models.

The frame, made of high-quality triple butted aluminum, impresses with its light weight and high rigidity values.

The very attractive appearance gives the bike an exclusive character.

-  X Vert 29
-  Rockshox FS Recon 29" 100mm
-  Shimano Deore XT SGS 12S
-  Shimano SLX 12S
-  Sram Level T 180mm | Front
-  Sram Level T 160mm | Rear
-  Shimano SLX 175mm 32T
-  Shimano SLX 10-51T 12S
-  KMC X12
-  ZZYX Cross Attack 29" | Front
-  ZZYX Cross Attack 29" | Rear
-  Michelin Force 57-622 | Front
-  Michelin Force 57-622 | Rear
-  Selle X-Base
-  ZZYX SL Alloy Seatpost 27.2mm
-  ZZYX SL Alloy Stem
-  ZZYX SL Alloy Handlebar

# XVERT 29



The Rendering is for Reference only

**FARBE COLOR**  Starry Black | Factory Copper

**BK28020**

 39 | 44 | 49 | 54

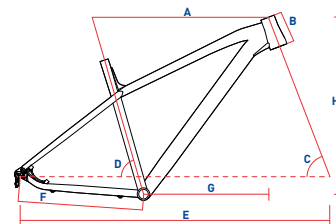

**X VERT 29**

CM	A	B	C	D	E	F	G	H
39	574	91	67	74	1119	442	405	611
44	596	99	67	74	1142	442	425	619
49	624	110	67	74	1171	442	450	629
54	649	121	67	74	1197	442	472	639

**FEATURES**

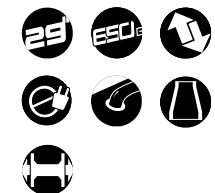



# X VERT PRO

# XVERT 29

Gefertigt aus hochwertigem Triple Butted Aluminium: Leicht und zugleich extrem steif.

Speziell verstärktes Steuerrohr – Tapered Headtube.

Innovative Farbkombinationen, neidische Blicke auf der Alm sind garantiert.

Made out of high quality Triple Butted Aluminium – light and stiff at the same time.

Specially reinforced tapered head tube.

Innovative color combinations, envious views of the alp are guaranteed.



- X Vert 29
- SR Suntour XCR32 Boost 29" 100mm
- L-TW00 A12-X 12S
- L-TW00 A12-X
- Clarks Clout 180mm I Front
- Clarks Clout 160mm I Rear
- L-TW00 A12 32T
- L-TW00 A12 10-50T 12S
- KMC X12
- ZZYX Cross Attack 29" I Front
- ZZYX Cross Attack 29" I Rear
- Continental Race King 29" x 2.2 I Front
- Continental Race King 29" x 2.2 I Rear
- Selle X-Base
- ZZYX SL Alloy Seatpost 27.2mm
- ZZYX SL Alloy Stem
- ZZYX SL Alloy Handlebar

The Rendering is for Reference only

**FARBE COLOR** Light Blue | Dark Blue | Racing Red

**BK28021**

39 | 44 | 49 | 54

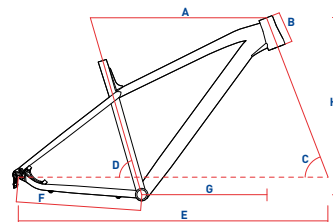

**X VERT 29**

CM	A	B	C	D	E	F	G	H
<b>39</b>	574	91	67	74	1119	442	405	611
<b>44</b>	596	99	67	74	1142	442	425	619
<b>49</b>	624	110	67	74	1171	442	450	629
<b>54</b>	649	121	67	74	1197	442	472	639

**FEATURES**



# XVERT 29

## X VERT ELITE

Gefertigt aus hochwertigem Triple Butted Aluminium: Leicht und zugleich extrem steif.

Speziell verstärktes Steuerrohr – Tapered Headtube.

Innovative Farbkombinationen, neidische Blicke auf der Alm sind garantiert.

Made out of high quality Triple Butted Aluminium – light and stiff at the same time.

Specially reinforced tapered head tube.

Innovative color combinations, envious views of the alp are guaranteed.



-  X Vert 29
-  SR Suntour XCM RL DS 29" 100mm
-  L-TW00 A11-X 115
-  L-TW00 A11- X
-  Clarks Clout 180mm | Front
-  Clarks Clout 160mm | Rear
-  Lasco 32T
-  L-TW00 A11 11-42T 115
-  KMC X11
-  ZZYX Cross Attack 29" | Front
-  ZZYX Cross Attack 29" | Rear
-  Innova IB-3014 29" x 2.25 | Front
-  Innova IB-3014 29" x 2.25 | Rear
-  corratec Sport Saddle
-  ZZYX SL Alloy Seatpost 27.2mm
-  ZZYX SL Alloy Stem
-  ZZYX SL Alloy Handlebar

The Rendering is for Reference only

**FARBE COLOR**  Jungle Green | Tactit Green | Dark Blue

**BK28022**

 39 | 44 | 49 | 54

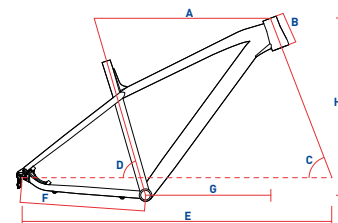

**X VERT 29**

CM	A	B	C	D	E	F	G	H
39	574	91	67	74	1119	442	405	611
44	596	99	67	74	1142	442	425	619
49	624	110	67	74	1171	442	450	629
54	649	121	67	74	1197	442	472	639

**FEATURES**





# X VERT EXPERT

Gefertigt aus hochwertigem Triple Butted Aluminium.

Komfortable Geometrie für Sicherheit und Fahrspaß auf langen MTB Touren über Stock und Stein.

Innovative Farbkombinationen, neidische Blicke auf der Alm sind garantiert.

Made out of high class Triple Butted Aluminium.

Comfortable geometry for safety and riding pleasure on long MTB Tours across stock and stone.

Innovative color combinations, envious views of the alp are guaranteed.

# XVERT 29



- X Vert 29
- HL 525D AMS 29" 100mm
- L-TW00 V5010-LX 10S
- L-TW00 V5010-10W
- Clarks Clout 180mm I Front
- Clarks Clout 160mm I Rear
- Lasco 32T
- L-TW00 A7 11-42T 10S
- KMC X10
- ZZYX Cross Attack 29" I Front
- ZZYX Cross Attack 29" I Rear
- Innova IA-1130 29" x 2.10 I Front
- Innova IA-1130 29" x 2.10 I Rear
- corratec Sport Saddle
- ZZYX SL Alloy Seatpost 30.9mm
- ZZYX SL Alloy Stem
- ZZYX SL Alloy Handlebar

The Rendering is for Reference only

**FARBE COLOR** Racing Red I Light Orange I Dark Blue

**BK28023**

39 | 44 | 49 | 54

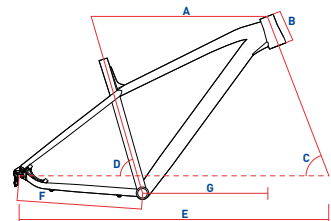

**X VERT 29**

CM	A	B	C	D	E	F	G	H
<b>34</b>	550	95	69	74	1076	450	376	606
<b>39</b>	575	95	69	74	1101	450	401	606
<b>44</b>	600	105	69	74	1127	450	423	615
<b>49</b>	625	115	69	74	1153	450	445	624
<b>54</b>	650	125	69	74	1179	450	468	634

**FEATURES**



# X VERT MOTION

**XVERT**

Gefertigt aus hochwertigem Triple Butted Aluminium.

Komfortable Geometrie für Sicherheit und Fahrspaß auf langen MTB Touren über Stock und Stein.











650B Laufräder extrem wendig – ideal für kleinere Fahrertypen.

Made out of high class Triple Butted Aluminium.

Comfortable geometry for safety and riding pleasure on long MTB Tours across stock and stone.

650B wheels are extremely flexible – perfectly for smaller bikers.



-  X Vert 650B
-  HL 525D AMS 650B 100mm
-  L-TWOO V4008 8S
-  L-TWOO V5008
-  L-TWOO V4008
-  Clarks Clout 180mm | Front
-  Clarks Clour 160mm | Rear
-  Lasco 22 | 36T
-  L-TWOO A3 11-34T 8S
-  KMC X8
-  ZZYX Cross Attack 650B | Front
-  ZZYX Cross Attack 650B | Rear
-  Innova IA-1130 27,5" x 2.10 | Front
-  Innova IA-1130 27,5" x 2.10 | Rear
-  corratec Sport Saddle
-  ZZYX SL Alloy Seatpost 27.2mm
-  ZZYX SL Alloy Stem
-  ZZYX SL Alloy Handlebar

The Rendering is for Reference only

**FARBE COLOR**  Lime Green | Sky BBlue | Dark Blue

**BK28024**

 34 | 39 | 44 | 49 | 54

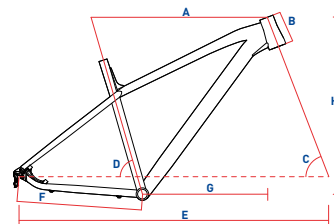

**X VERT 650B**

CM	A	B	C	D	E	F	G	H
34	550	100	69	73	1064	450	370	587
39	570	105	69	73	1085	450	389	591
44	590	105	69	73	1092	450	400	611
49	610	125	69	73	1125	450	429	601
54	630	135	69	73	1147	450	446	610

**FEATURES**





# X VERT HALCON

**XVERT**

Gefertigt aus hochwertigem Triple Butted Aluminium.

Komfortable Geometrie für Sicherheit und Fahrspaß auf langen MTB Touren über Stock und Stein.



















650B Laufräder extrem wendig – ideal für kleinere Fahrertypen.

Made out of high class Triple Butted Aluminium.

Comfortable geometry for safety and riding pleasure on long MTB Tours across stock and stone.

650B wheels are extremely flexible – perfectly for smaller bikers.



-  X Vert 650B
-  HL 565D AMS 650B 100mm
-  Microshift M26S 8S
-  Microshift M20 Mezzo
-  Microshift TS39 8S
-  JAK 2a Hydraulic
-  JAK 2a Hydraulic
-  ZZYX Crank 42 | 34 | 24T
-  Microshift H081 11-34T 8S
-  Taya TB-65 8S
-  ZZYX Cross Attack 650B | Front
-  ZZYX Cross Attack 650B | Rear
-  Innova IA-1130 27.5" x 2.10 | Front
-  Innova IA-1130 27.5" x 2.10 | Rear
-  corratec Sport Saddle
-  ZZYX SL Alloy Seatpost 30.9 mm
-  ZZYX SL Alloy Stem
-  ZZYX SL Alloy Handlebar

The Rendering is for Reference only

**FARBE COLOR**  Pearlized Blue | Lime Green

**BK28025**

 34 | 39 | 44 | 49 | 54

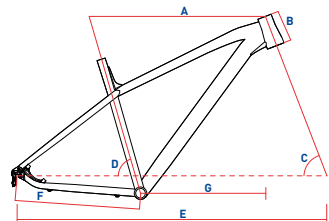

**X VERT 650B**

CM	A	B	C	D	E	F	G	H
34	550	100	69	73	1064	450	370	587
39	570	105	69	73	1085	450	389	591
44	590	105	69	73	1092	450	400	611
49	610	125	69	73	1125	450	429	601
54	630	135	69	73	1147	450	446	610

**FEATURES**



# X VERT ROCK TEAM

**XVERT**

Das ideale Rad für den Einstieg in die Welt des Mountainbikens.

Das Bike vermittelt Freude am Fahren.

Dank hochwertiger Ausstattung ist dieses stylische Bike alles andere als ein herkömmliches Kinderfahrrad.

The perfect bike for all beginners and upcoming MTB Stars.

Above all the main purpose of the X Vert Young Series is the joy of riding your bike.

Thanks to high-quality equipment, this stylish bike is anything but a conventional children's bike.



-  X Vert 26
-  HL CH-525 26" 100mm
-  Shimano Altus 8S
-  Shimano Tourney
-  Shimano M315 8S
-  Tektro HD-M275 180mm | Front
-  Tektro HD-M275 160mm | Rear
-  Shimano Tourney 42 | 32 | 22T
-  Shimano CS-HG31 11-34T 8S
-  KMC X8
-  ZYZX Cross Attack 26" | Front
-  ZYZX Cross Attack 26" | Rear
-  Continental Mountain King 26" x 2.30 | Front
-  Continental Mountain King 26" x 2.30 | Rear
-  corrated Youth Saddle
-  ZYZX SL Alloy Seatpost 27.2mm
-  ZYZX SL Alloy Stem
-  ZYZX SL Alloy Handlebar

The Rendering is for Reference only

**FARBE COLOR**  Blue | Orange

**BK28030**

 34 | 39

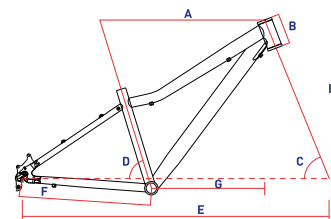

**X VERT 26**

CM	A	B	C	D	E	F	G	H
34	530	100	69	73	1021	420	365	567
39	540	100	69	73	1031	420	366	567

**FEATURES**





# X VERT ROCK

Das ideale Rad für den Einstieg in die Welt des Mountainbikens.

Das Bike vermittelt vor allem Eines: Freude am Fahren.

Dank hochwertiger Ausstattung ist dieses stylische Bike alles andere als ein herkömmliches Kinderfahrrad.

















The perfect bike for all beginners and upcoming MTB Stars.

Above all the main purpose of the X Vert Young Series is the joy of riding your bike.

Thanks to high-quality equipment, this stylish bike is anything but a conventional children's bike.

# XVERT



-  X Vert 26
-  HL CH-565DAMS 26" 80mm
-  Shimano Tourney 8S
-  Shimano Tourney
-  Shimano Tourney 8S
-  Tekro MD-M280 180mm I Front
-  Tekro MD-M280 160mm I Rear
-  Shimano TY501 42 | 34 | 24T
-  G. Falcon CS-852 11-32T 8S
-  KMC X8
-  ZZYX Cross Attack 26" I Front
-  ZZYX Cross Attack 26" I Rear
-  Continental Mountain King 26" x 2.30 I Front
-  Continental Mountain King 26" x 2.30 I Rear
-  corratec Youth Saddle
-  ZZYX SL Alloy Seatpost 27.2mm
-  ZZYX SL Alloy Stem
-  ZZYX SL Alloy Handlebar

The Rendering is for Reference only

**FARBE COLOR**  Anthracite | Orange | Mustard Yellow

**BK28031**

 34 | 39

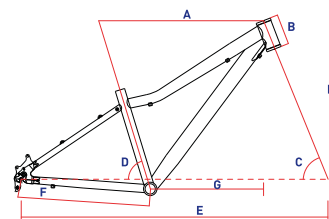

**X VERT 26**

CM	A	B	C	D	E	F	G	H
34	530	100	69	73	1021	420	365	567
39	540	100	69	73	1031	420	366	567

**FEATURES**



# X VERT TEEN

Das ideale Rad für den Einstieg in die Welt des Mountainbikens.

Das Bike vermittelt vor allem Eines: Freude am Fahren.















Dank hochwertiger Ausstattung ist dieses stylische Bike alles andere als ein herkömmliches Kinderfahrrad.

The perfect bike for all beginners and upcoming MTB stars.

Above all the main purpose of the X Vert Young Series is the joy of riding your bike.

Thanks to high-quality equipment, this stylish bike is anything but a conventional children's bike.



-  X Vert Kid 24"
-  ZZYX Select 24" 50mm
-  Shimano Tourney 7S
-  Shimano Altus
-  ZZYX V-Brake
-  ZZYX V-Brake
-  Shimano Crankset 35T
-  Shimano TZ500 14-28T
-  KMC HV-500
-  ZZYX Cross Attack 20"
-  ZZYX Cross Country 20"
-  ZZYX Youth Saddle
-  ZZYX SL Alloy Seatpost
-  ZZYX SL Alloy Stem
-  ZZYX SL Alloy Handlebar

The Rendering is for Reference only

**FARBE COLOR**  Green | Lime Green

**BK28032**

 uni

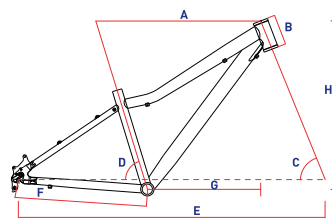

**X VERT 24**

CM	A	B	C	D	E	F	G	H
31	510	105	69	71	949	415	338	500

**FEATURES**





# X VERT KID

Das ideale Rad für den Einstieg in die Welt des Mountainbikens.

Das Bike vermittelt vor allem Eines: Freude am Fahren.

Dank hochwertiger Ausstattung ist dieses stylische Bike alles andere als ein herkömmliches Kinderfahrrad.















The perfect bike for all beginners and upcoming MTB stars.

Above all the main purpose of the X Vert Young Series is the joy of riding your bike.

Thanks to high-quality equipment, this stylish bike is anything but a conventional children's bike.

**XVERT**



-  X Vert Kid 20"
-  ZZYX Select 20" 30mm
-  Shimano Tourney 7S
-  Shimano Tourney 7S
-  ZZYX V-Brake
-  ZZYX V-Brake
-  Shimano Crankset 35T
-  Shimano TZ500 14-28T
-  KMC HV-500
-  ZZYX Cross Attack 20"
-  ZZYX Cross Country 20"
-  ZZYX Youth Saddle
-  ZZYX SL Alloy Seatpost
-  ZZYX SL Alloy Stem
-  ZZYX SL Alloy Handlebar

The Rendering is for Reference only

FARBE COLOR  Light Blue | White | Yellow

**BK28033**

 uni

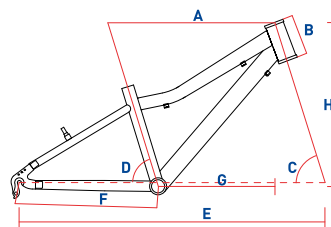

**X VERT 20**

CM	A	B	C	D	E	F	G	H
27	430	105	69	73	851	360	269	489

**FEATURES**





# THE TREKKINGBIKE

Die speziell für diesen Einsatzbereich abgestimmte Geometrie der Trekkingräder garantiert Dir ein ergonomisches Fahren. Hochwertige Komponenten und eine stylische Optik runden das gesamte Komfortpaket ab und verleihen der corratec City & Trekking Range einen exklusiven Charakter.

The geometry of the trekking bikes are specially developed for urban as well as trekking rides across stick and stone. In addition the City & Trekking bikes of corratec combines high quality components and stylish designs. These features provide the corratec bikes of the category City & Trekking with an exclusive character.







● Factory Copper | Pearlized Black



# C29 ELITE TRAPEZ

C29er

Die Premium Klasse unter den Trekking Bikes.

Das urbane Rad bietet mit der 29 Zoll Bereifung höchstmögliche Dämpfung und ideale Rolleigenschaften.













Die ergonomische Geometrie des Rahmens und der verbaute Speedlifter garantieren Dir maximalen Komfort.

The premium class among trekking bikes.

With its 29 inch tires, the urban bike offers the highest possible damping and ideal rolling properties.

The ergonomic geometry of the frame and the built-in speedlifter ensures maximum comfort.



-  corratec C29
-  C29er Alloy Fork
-  Shimano Deore XT 10S
-  Shimano Deore
-  Shimano Deore 10S
-  CLARKS M2, 2-Piston 180mm | Front
-  CLARKS M2, 2-Piston 160mm | Rear
-  Shimano Deore 48 | 36 | 26T
-  Shimano CS-HG50 11-36T 10S
-  KMC X10
-  ZZYX 29er Disc I Front
-  ZZYX 29er Disc I Rear
-  Continental Contact Cruiser 55-622 | Front
-  Continental Contact Cruiser 55-622 | Rear
-  corratec Classic Leather Saddle
-  ZZYX SL Alloy Seatpost 27.2mm
-  ZZYX Speedlifter
-  ZZYX Trekking Handlebar

The Rendering is for Reference only

FARBE COLOR

 Chrome | Red | Silver

**BK28200**

 45 | 48 | 51 | 54

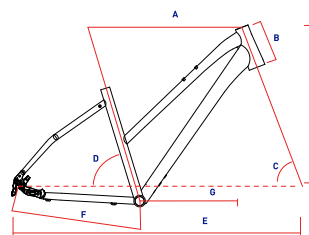

**CORRATEC C29 TRAPEZ**

CM	A	B	C	D	E	F	G	H
45	578	155	69	73	1103	465	398	589
48	590	155	69	73	1115	465	410	589
51	598	190	69	72	1120	465	402	621
54	607	190	69	72	1129	465	402	621

FEATURES





# C29 ELITE GENT

C29er

Dein idealer Begleiter zur täglichen Fahrt in die Arbeit oder für sportliche Ausfahrten.

Das urbane Rad bietet mit der 29 Zoll Bereifung höchstmögliche Dämpfung und ideale Rolleigenschaften.

Die ergonomische Geometrie des Rahmens und der verbaute Speedlifter garantieren Dir maximalen Komfort.

The premium class among trekking bikes.

With its 29 inch tires, the urban bike offers the highest possible damping and ideal rolling properties.

The ergonomic geometry of the frame and the built-in speedlifter ensures maximum comfort.



-  corratec C29
-  C29er Alloy Fork
-  Shimano Deore XT 10S
-  Shimano Deore
-  Shimano Deore 10S
-  CLARKS M2, 2-Piston 180mm I Front
-  CLARKS M2, 2-Piston 160mm I Rear
-  Shimano Deore 48 | 36 | 26T
-  Shimano CS-HG50 11-36T 10S
-  KMC X10
-  ZZYX 29er Disc I Front
-  ZZYX 29er Disc I Rear
-  Continental Contact Cruiser 55-622 I Front
-  Continental Contact Cruiser 55-622 I Rear
-  corratec Classic Leather Saddle
-  ZZYX SL Alloy Seatpost 27.2mm
-  ZZYX Speedlifter
-  ZZYX Trekking Handlebar

The Rendering is for Reference only

FARBE COLOR

 Chrome | Red | Silver

**BK28201**

 48 | 51 | 54 | 57 | 61

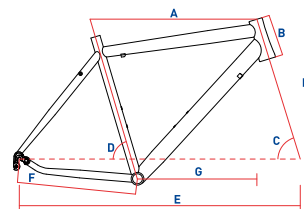

**CORRATEC C29 GENT**

CM	A	B	C	D	E	F	G	H
48	579	140	69	73	1115	465	404	575
51	587	155	69	72	1106	465	401	589
54	596	170	69	72	1116	465	405	603
57	610	185	69	72	1103	465	415	617
61	622	200	69	72	1144	465	423	631

**FEATURES**



# C29 BASE TRAPEZ

C29er

Dein idealer Begleiter zur täglichen Fahrt in die Arbeit oder für sportliche Ausfahrten.

Das urbane Rad bietet mit der 29 Zoll Bereifung höchstmögliche Dämpfung und ideale Rolleigenschaften.

















Die ergonomische Geometrie des Rahmens und der verbaute Speedlifter garantieren Dir maximalen Komfort.

The premium class among trekking bikes.

With its 29 inch tires, the urban bike offers the highest possible damping and ideal rolling properties.

The ergonomic geometry of the frame and the built-in speedlifter ensures maximum comfort.



-  corratec C29
-  C29er Alloy Fork
-  Shimano Alfine 8S
-  Shimano Alfine 8S
-  CLARKS M2, 2-Piston 180mm | Front
-  CLARKS M2, 2-Piston 160mm | Rear
-  Miranda 38T
-  Shimano CS-S500 Alfine 18T 8S
-  KMC X8
-  ZYZX 29er Disc I Front
-  ZYZX 29er Disc I Rear
-  Continental Contact Cruiser 55-622 | Front
-  Continental Contact Cruiser 55-622 | Rear
-  corratec Classic Leather Saddle
-  ZYZX SL Alloy Seatpost 27.2mm
-  ZYZX Speedlifter
-  ZYZX Trekking Handlebar

The Rendering is for Reference only

**FARBE COLOR**  Marine Blue | Grey Blue | Silver

**BK28202**

 45 | 48 | 51 | 54

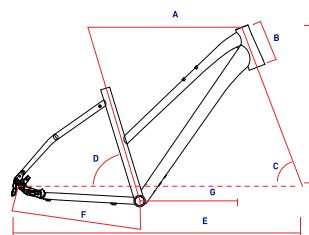

## CORRATEC C29 TRAPEZ

CM	A	B	C	D	E	F	G	H
45	578	155	69	73	1103	465	398	589
48	590	155	69	73	1115	465	410	589
51	598	190	69	72	1120	465	402	621
54	607	190	69	72	1129	465	402	621

## FEATURES





# C29 BASE GENT

C29er

Dein idealer Begleiter zur täglichen Fahrt in die Arbeit oder für sportliche Ausfahrten.

Das urbane Rad bietet mit der 29 Zoll Bereifung höchstmögliche Dämpfung und ideale Rolleigenschaften.

















Die ergonomische Geometrie des Rahmens und der verbaute Speedlifter garantieren Dir maximalen Komfort.

The premium class among trekking bikes.

With its 29 inch tires, the urban bike offers the highest possible damping and ideal rolling properties.

The ergonomic geometry of the frame and the built-in speedlifter ensures maximum comfort.



-  corratec C29
-  C29er Alloy Fork
-  Shimano Alfine 8S
-  Shimano Alfine 8S
-  CLARKS M2, 2-Piston 180mm | Front
-  CLARKS M2, 2-Piston 160mm | Rear
-  Miranda 38T
-  Shimano CS-S500 Alfine 18T 8S
-  KMC X8
-  ZZYX 29er Disc | Front
-  ZZYX 29er Disc | Rear
-  Continental Contact Cruiser 55-622 | Front
-  Continental Contact Cruiser 55-622 | Rear
-  corratec Classic Leather Saddle
-  ZZYX SL Alloy Seatpost 27.2mm
-  ZZYX Speedlifter
-  ZZYX Trekking Handlebar

The Rendering is for Reference only

FARBE COLOR  Marine Blue | Grey Blue | Silver

**BK28203**

 48 | 51 | 54 | 57 | 61

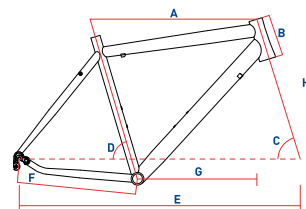

**CORRATEC C29 GENT**

CM	A	B	C	D	E	F	G	H
48	579	140	69	73	1115	465	404	575
51	587	155	69	72	1106	465	401	589
54	596	170	69	72	1116	465	405	603
57	610	185	69	72	1103	465	415	617
61	622	200	69	72	1144	465	423	631

**FEATURES**



# MTC ELITE TRAPEZ

**MTC**

Das Mountaincrossbike ist nun auch als Bio Bike erhältlich.

Mit 29 Zoll Mountainbike Bereifung ist das Bike für jeden Untergrund die perfekte Wahl.

Eine bereits installierte Lichtanlage bietet zusätzliche Sicherheit im Straßenverkehr.

The mountain cross bike is now also available as an organic bike.

With 29 inch mountain bike tires, the bike is the perfect choice for every surface.

An already installed light system offers additional safety in road traffic.



-  corratec MTC
-  SR Suntour XCM LO DS 29" 80mm
-  Shimano Deore XT 10S
-  Shimano Deore
-  Shimano Deore 10S
-  CLARKS M2, 2-Piston 180mm | Front
-  CLARKS M2, 2-Piston 160mm | Rear
-  Shimano Deore 48 | 36 | 26T
-  Shimano CS-HG50 11-36T 10S
-  KMC X10
-  ZZYX 29er Disc | Front
-  ZZYX 29er Disc | Rear
-  Schwalbe Smart Sam 57-622 | Front
-  Schwalbe Smart Sam 57-622 | Rear
-  corratec Comfort Saddle
-  ZZYX SL Alloy Seatpost 27.2mm
-  ZZYX SL Alloy Stem
-  ZZYX Trekking Handlebar

The Rendering is for Reference only

**FARBE COLOR**  Metallic Silver | Blue | Orange

**BK28210**

 45 | 50 | 55

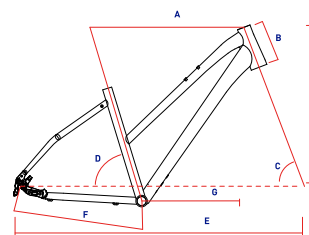

## CORRATEC MTC TRAPEZ

CM	A	B	C	D	E	F	G	H
45	590	150	69	73	1106	445	394	640
50	605	160	69	73	1121	445	406	649
55	630	170	69	73	1148	445	428	658

## FEATURES





# MTC ELITE GENT



Das Mountaincrossbike ist nun auch als Bio Bike erhältlich.

Mit 29 Zoll Mountainbike Bereifung ist das Bike für jeden Untergrund die perfekte Wahl.

Eine bereits installierte Lichtanlage bietet zusätzliche Sicherheit im Straßenverkehr.

The mountain cross bike is now also available as an organic bike.

With 29 inch mountain bike tires, the bike is the perfect choice for every surface.

An already installed light system offers additional safety in road traffic.



-  corratec MTC
-  SR Suntour XCM LO DS 29" 80mm
-  Shimano Deore XT 10S
-  Shimano Deore
-  Shimano Deore 10S
-  CLARKS M2, 2-Piston 180mm | Front
-  CLARKS M2, 2-Piston 160mm | Rear
-  Shimano Deore 48 | 36 | 26T
-  Shimano CS-HG50 11-36T 10S
-  KMC X10
-  ZZYX 29er Disc | Front
-  ZZYX 29er Disc | Rear
-  Schwalbe Smart Sam 57-622 | Front
-  Schwalbe Smart Sam 57-622 | Rear
-  corratec Comfort Saddle
-  ZZYX SL Alloy Seatpost 27.2mm
-  ZZYX SL Alloy Stem
-  ZZYX Trekking Handlebar

The Rendering is for Reference only

FARBE COLOR  Metallic Silver | Blue | Orange

**BK28211**

 50 | 55 | 60

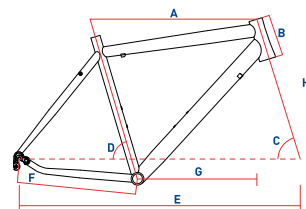

## CORRATEC MTC GENT

CM	A	B	C	D	E	F	G	H
50	615	140	69	73	1130	445	422	630
55	630	150	69	73	1146	445	434	640
60	645	160	69	73	1162	445	446	649

## FEATURES



# MTC EXPERT TRAPEZ

**MTC**

Das Mountaincrossbike ist nun auch als Bio Bike erhältlich.

Mit 29 Zoll Mountainbike Bereifung ist das Bike für jeden Untergrund die perfekte Wahl.













Eine bereits installierte Lichtanlage bietet zusätzliche Sicherheit im Straßenverkehr.

The mountain cross bike is now also available as an organic bike.

With 29 inch mountain bike tires, the bike is the perfect choice for every surface.

An already installed light system offers additional safety in road traffic.



-  corratec MTC
-  SR Suntour XCM LO DS 29" 80mm
-  Shimano Alivio 9S
-  Shimano Acera
-  Shimano Altus 9S
-  CLARKS M2, 2-Piston 180mm | Front
-  CLARKS M2, 2-Piston 160mm | Rear
-  Shimano FC-MT210 46 | 30T
-  Shimano CS-HG200 11-36T 9S
-  KMC X9
-  ZZYX 29er Disc | Front
-  ZZYX 29er Disc | Rear
-  Schwalbe Smart Sam 57-622 | Front
-  Schwalbe Smart Sam 57-622 | Rear
-  corratec Comfort Saddle
-  ZZYX SL Alloy Seatpost 27.2mm
-  ZZYX SL Alloy Stem
-  ZZYX Trekking Handlebar

The Rendering is for Reference only

FARBE COLOR

 Orange | Sand | Black

**BK28212**

 45 | 50 | 55

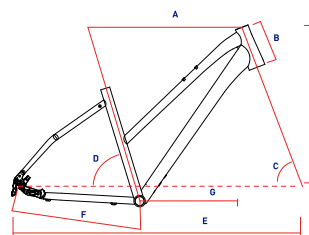

**CORRATEC MTC TRAPEZ**

CM	A	B	C	D	E	F	G	H
45	590	150	69	73	1106	445	394	640
50	605	160	69	73	1121	445	406	649
55	630	170	69	73	1148	445	428	658

FEATURES





# MTC EXPERT GENT



Das Mountaincrossbike ist nun auch als Bio Bike erhältlich.

Mit 29 Zoll Mountainbike Bereifung ist das Bike für jeden Untergrund die perfekte Wahl.





Eine bereits installierte Lichtanlage bietet zusätzliche Sicherheit im Straßenverkehr.

The mountain cross bike is now also available as an organic bike.

With 29 inch mountain bike tires, the bike is the perfect choice for every surface.

An already installed light system offers additional safety in road traffic.



-  corratec MTC
-  SR Suntour XCM LO DS 29" 80mm
-  Shimano Alivio 9S
-  Shimano Acera
-  Shimano Altus 9S
-  CLARKS M2, 2-Piston 180mm | Front
-  CLARKS M2, 2-Piston 160mm | Rear
-  Shimano FC-MT210 46 | 30T
-  Shimano CS-HG200 11-36T 9S
-  KMC X9
-  ZZYX 29er Disc | Front
-  ZZYX 29er Disc | Rear
-  Schwalbe Smart Sam 57-622 | Front
-  Schwalbe Smart Sam 57-622 | Rear
-  corratec Comfort Saddle
-  ZZYX SL Alloy Seatpost 27.2mm
-  ZZYX SL Alloy Stem
-  ZZYX Trekking Handlebar

The Rendering is for Reference only

FARBE COLOR  Orange | Sand | Black

**BK28213**

**50 | 55 | 60**

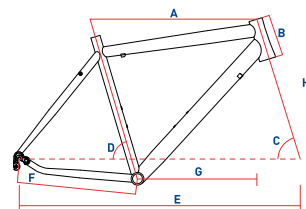

**CORRATEC MTC GENT**

CM	A	B	C	D	E	F	G	H
<b>50</b>	615	140	69	73	1130	445	422	630
<b>55</b>	630	150	69	73	1146	445	434	640
<b>60</b>	645	160	69	73	1162	445	446	649

**FEATURES**



# MTC BASE TRAPEZ

**MTC**

Das Mountaincrossbike ist nun auch als Bio Bike erhältlich.

Mit 29 Zoll Mountainbike Bereifung ist das Bike für jeden Untergrund die perfekte Wahl.













Eine bereits installierte Lichtanlage bietet zusätzliche Sicherheit im Straßenverkehr.

The mountain cross bike is now also available as an organic bike.

With 29 inch mountain bike tires, the bike is the perfect choice for every surface.

An already installed light system offers additional safety in road traffic.



-  corratec MTC
-  SR Suntour XCM LO DS 29" 80mm
-  Shimano Alfine 8S
-  Shimano Alfine 8S
-  CLARKS M2, 2-Piston 180mm I Front
-  CLARKS M2, 2-Piston 160mm I Rear
-  Miranda 38T
-  Shimano CS-S500 Alfine 18T 8S
-  KMC X8
-  ZZYX 29er Disc I Front
-  ZZYX 29er Disc I Rear
-  Schwalbe Smart Sam 57-622 I Front
-  Schwalbe Smart Sam 57-622 I Rear
-  corratec Comfort Saddle
-  ZZYX SL Alloy Seatpost 27.2mm
-  ZZYX SL Alloy Stem
-  ZZYX Trekking Handlebar

The Rendering is for Reference only

FARBE COLOR  Blue | Red | Silver

**BK28214**

 45 | 50 | 55

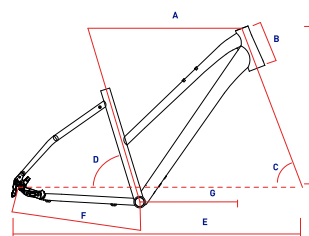

## CORRATEC MTC TRAPEZ

CM	A	B	C	D	E	F	G	H
45	590	150	69	73	1106	445	394	640
50	605	160	69	73	1121	445	406	649
55	630	170	69	73	1148	445	428	658

## FEATURES





# MTC BASE GENT



Das Mountaincrossbike ist nun auch als Bio Bike erhältlich.

Mit 29 Zoll Mountainbike Bereifung ist das Bike für jeden Untergrund die perfekte Wahl.









Eine bereits installierte Lichtanlage bietet zusätzliche Sicherheit im Straßenverkehr.

The mountain cross bike is now also available as an organic bike.

With 29 inch mountain bike tires, the bike is the perfect choice for every surface.

An already installed light system offers additional safety in road traffic.



-  corratec MTC
-  SR Suntour XCM LO DS 29" 80mm
-  Shimano Alfine 8S
-  Shimano Alfine 8S
-  CLARKS M2, 2-Piston 180mm | Front
-  CLARKS M2, 2-Piston 160mm | Rear
-  Miranda 38T
-  Shimano CS-S500 Alfine 18T 8S
-  KMC X8
-  ZZYX 29er Disc | Front
-  ZZYX 29er Disc | Rear
-  Schwalbe Smart Sam 57-622 | Front
-  Schwalbe Smart Sam 57-622 | Rear
-  corratec Comfort Saddle
-  ZZYX SL Alloy Seatpost 27.2mm
-  ZZYX SL Alloy Stem
-  ZZYX Trekking Handlebar

The Rendering is for Reference only

FARBE COLOR  Blue | Red | Silver

**BK28215**

 50 | 55 | 60

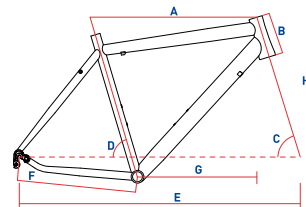

## CORRATEC MTC GENT

CM	A	B	C	D	E	F	G	H
50	615	140	69	73	1130	445	422	630
55	630	150	69	73	1146	445	434	640
60	645	160	69	73	1162	445	446	649

## FEATURES



# KLEIDUNG CLOTHING

Um Höchstleistungen auf dem Rad zu erbringen, benötigt man das passende Equipment. Deshalb legen wir bei der Bekleidung von corratec sehr viel Wert auf hochwertige Materialien und beste Schneiderkunst direkt aus Italien. Die Bekleidungsline reicht von der wettkampforientierten World Team Line bis hin zur sportlichen Basic Line.

At corratec our quality standards are not limited to our bikes, but extends to all our products and services. Therefore, it's the purpose to fashion our partners, athletes and consumers with only the finest apparels. Our clothing range contains the corratec competition clothing "World Team Line", the sportive "Basic Line" and much more.

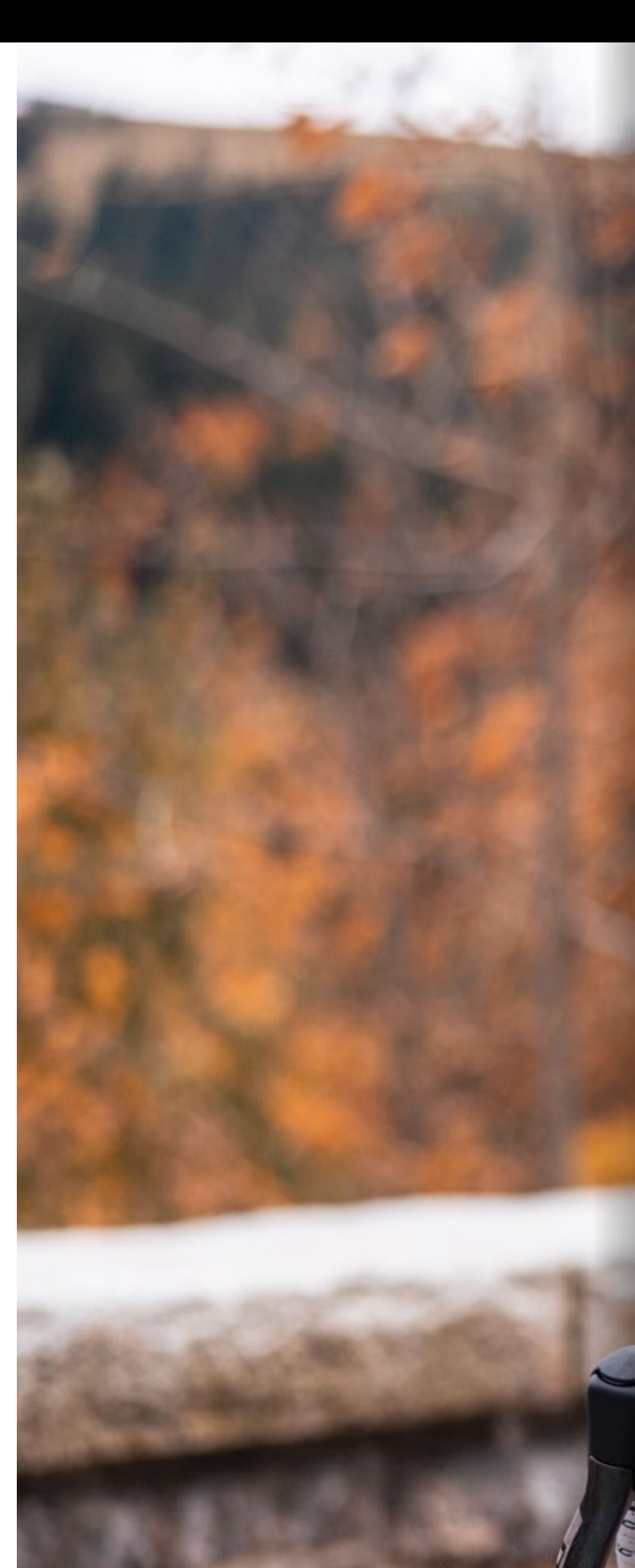





# E-BIKE LINE



## **E-BIKE TREKKING TRIKOT**

elastisches Silikon-Hüftband

Farben: Blau

Größe: XXS-5XL

**BC27006**

## **E-BIKE TREKKING JERSEY**

Silicon elastic band

Color: Blue

Sizes: XXS-5XL

**BC27006**



## **E-BIKE TRAIL TRIKOT**

elastisches Silikon-Hüftband

Farben: Blau

Größe: XXS-5XL

**BC27007**

## **E-BIKE TRAIL JERSEY**

Silicon elastic band

Color: Blue

Sizes: XXS-5XL

**BC27007**



## **E-BIKE LINE HERREN**

elastisches Silikon-Hüftband

Farben: schwarz/grau

Größe: XXS-5XL

**BC26008**

## **E-BIKE LINE GENT**

Silicon elastic band

Color: black/gray

Sizes: XXS-5XL

**BC26009**



## **E-BIKE LINE DAMEN**

Farben: schwarz/blau/neon grün

Größe: XXS-5XL

**BC26009**

## **E-BIKE LINE WOMAN**

Colors: black/blue/neon green

Sizes: XXS-5XL

**BC26009**



## **E-MTB FREERIDE SHORT**

Farben: dark

Größe: XXS-5XL

**BC27008**

## **E-MTB FREERIDE SHORT**

Colors: dark

Sizes: XXS-5XL

**BC27008**







# WORLD TEAM LINE

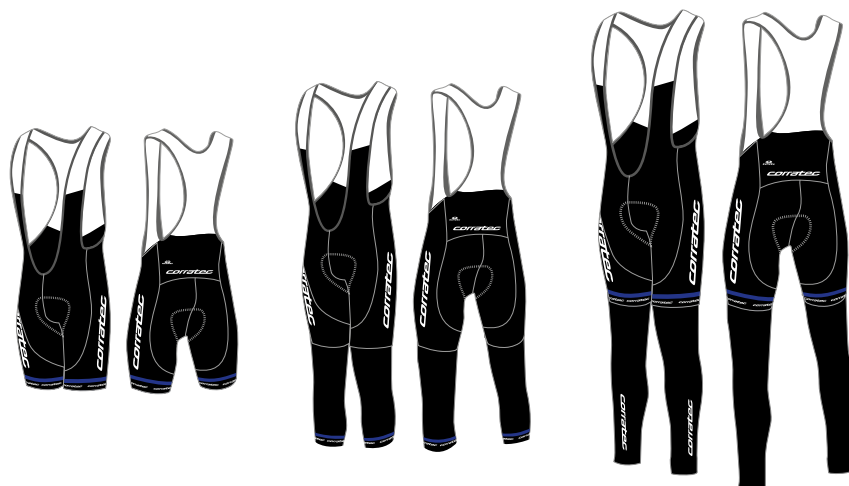

## BIBTIGHT SHORT

- Lycra 225g für hohe Kompression
- anatomisch geformt
- elastische Silikon Beinabschlüsse
- Vuelta Carbon S.A.T High resistant 4-fach abgenäht

Größen: XXS-4XL

**BC22007**

## BIBTIGHT 3/4

Größen: XXS-5XL

**BC22009**

## BIBTIGHT LANG

Größen: XS-4XL

**BC22010**

## LANGARM JERSEY

- 100% Polyester light
- 3 offene Taschen
- elastisches Silikon-Abschlussband

Größen: XS-4XL

**BC21007**

## BIBTIGHT SHORT

- Lycra 225g
- anatomically formed
- customizeable elastic with silicon
- high resistant 4 needles flatlocks stitching

Sizes: XXS-4XL

**BC22007**

## BIBTIGHT 3/4

Sizes: XXS-5XL

**BC22009**

## BIBTIGHT LONG

Sizes: XS-4XL

**BC22010**

## LONG SLEEVE JERSEY

- 100% polyester light
- 3 open pockets
- silicon elastic on waist

Sizes: XS-4XL

**BC21007**



## KURZARMTRIKOT

- 62% Polyester, 38% Polyester PBT, extrem schnell trocknend, antibakteriell
- Carbon fiber mesh für beste Belüftung und Feuchtigkeitsmanagement

Größen: XXS-4XL

**BC21000**

## ÄRMELLOSES JERSEY

Größen: XS-4XL

**BC21008**

## WINTER JACKE

- Wind- und wasserabweisend
- 3 offene Taschen & ein wasserdichtes Staufach mit Reißverschluss

Größen: XS-4XL

**BC21009**

## WIND-WESTE

- Weste mit Polyester-Mesh-Rücken
- Teflon-Beschichtung
- Silikon-Hüftband für besten Sitz

Größen: XS-4XL

**BC21005**

## SHORT SLEEVES JERSEY

- 62% Polyester, 38% Polyester PBT, Superrapid drying, antibacterial properties
- carbon fiber mesh side panels for better ventilation, moisture management

Sizes: XXS-4XL

**BC21000**

## SLEEVELESS JERSEY

Sizes: XS-4XL

**BC21008**

## WINTER JACKET

- wind&waterproof material
- 3 open pockets and one middle waterproof pocket with zipper

Sizes: XS-4XL

**BC21009**

## WINDPROOF VEST

- vest with mesh back 100% P
- teflon protection
- silicon elastic on waist

Sizes: XS-4XL

**BC21005**





#### CORRATEC MTB WELTMEISTER JERSEY

- 62% Polyester, 38% Polyester PBT, extrem schnell trocknend, antibakteriell
- Carbon fiber mesh für beste Belüftung und Feuchtigkeitsmanagement

Größen: XXS-4XL

**BC27009**



#### CORRATEC MTB WORLD CHAMPION JERSEY

- 62% Polyester, 38% Polyester PBT, Superrapid drying, antibacterial properties
- carbon fiber mesh side panels for better ventilation, moisture management

Sizes: XXS-4XL

**BC27009**



#### TEAM LINE SHORT LADY

- Lycra 225g für hohe Kompression
- elastische Silikon-Beinabschlüsse

Größen: XS-4XL

**PS20004**

#### TEAM LINE SHORT LADY

- Lycra 225g
- customizable elastic with silicon

Sizes: XXS-4XL

**PS20004**

## FUNCTIONAL



#### FUNKTIONALE ÜBERSCHUHE

Größen: S-XXL

**AC23004**

#### FUNKTIONALE ARMWÄRMER

Größen: S-XL

**AC23002**

#### FUNKTIONALE HANDSCHUHE

Größen: XS-4XL

**KURZ AC23000**

**LANG AC23001**

#### FUNKTIONALE SOCKEN

Größen: S/M; L/XL

**AC23003**

#### FUNCTIONAL OVERSHOES

Sizes: S-XXL

**AC23004**

#### FUNCTIONAL ARMWARMERS

Sizes: S-XL

**AC23002**

#### FUNCTIONAL GLOVES

Sizes: XS-4XL

**SHORT AC23000**

**LONG AC23001**

#### FUNCTIONAL SOCKS

Sizes: S/M; L/XL

**AC23003**

# BASIC LINE LADY



## KURZARM TRIKOT LADY

- Interpower-bi-Stretch Material
- Versteckter Reißverschluss
- elastisches Silikon-Hüftband

• Farben: Blau  
Größe: XXS-5XL

blau **BC27002**

## BIBSHORT LADY

- Lycra Kompressions-Material
- Flache Nähte
- Gummis aus Silikon am Ärmelende

• Farben: Blau  
Größe: XXS-5XL

blau **BC27005**

## SHORT SLEEVE JERSEY LADY

- Interpower-bi stretch fabric
- Long zip cover
- Silikon elastic on waiste

• Colors: Blue  
Sizes: XXS-5XL

blue **BC27002**

## BIBSHORT LADY

- Lycra Sport Compression fabric
- Flat seams

• Colors: Blue  
Sizes: XXS-5XL

blue **BC27005**



## KURZARM TRIKOT LADY

- Interpower-bi-Stretch Material
- Versteckter Reißverschluss
- elastisches Silikon-Hüftband

• Farben: orange/gelb, grau/weiss  
Größe: XXS-5XL

orange/gelb **BC26002**

grau/weiss **BC26003**

## BIBSHORT LADY

- Lycra Kompressions-Material
- Flache Nähte
- Gummis aus Silikon am Ärmelende

• Farben: orange/gelb, grau/weiss  
Größe: XXS-5XL

orange/gelb **BC26006**

grau/weiss **BC26007**



## SHORT SLEEVE JERSEY LADY

- Interpower-bi stretch fabric
- Long zip cover
- Silicon elastic on waiste

• Colors: orange/yellow, gray/white  
Sizes: XXS-5XL

orange/yellow **BC26002**

gray/white **BC26003**

## BIBSHORT LADY

- Lycra Sport Compression fabric
- Flat seams

• Colors: orange/yellow, gray/white  
Sizes: XXS-5XL

orange/yellow **BC26006**

gray/white **BC26007**



# BASIC LINE GENT



## KURZARM TRIKOT GENT

- Atmungsaktives Material
- Meshsätze an den Seiten
- Gummis aus Silikon am Ärmelende
- Farben: Grün, Grau

Größen: XXS-5XL

grün **BC27000**

grau **BC27001**

## BIBSHORT GENT

- Lycra Kompressions-Material
- Flache Nähte
- Gummis aus Silikon am Ärmelende
- Farben: Grün, Grau

Größe: XXS-5XL

grün **BC27003**

grau **BC27004**



## SHORT SLEEVES JERSEY GENT

- Airbreath polyester
- Mesh inserts on both sides
- Siliconed elastics on the sleeve openings
- Colors: Green, Gray

Sizes: XXS-5XL

green **BC27000**

gray **BC27001**

## BIBSHORT GENT

- Lycra Sport Compression fabric
- Flat seams

• Colors: Green, Gray

Sizes: XXS-5XL

green **BC27003**

gray **BC27004**



## KURZARM TRIKOT GENT

- Atmungsaktives Material
- Meshsätze an den Seiten
- Gummis aus Silikon am Ärmelende
- Farben: orange/gelb, grau/weiss

Größen: XXS-5XL

orange/gelb **BC26000**

grau/weiss **BC26001**

## BIBSHORT GENT

- Lycra Kompressions-Material
- Flache Nähte
- Gummis aus Silikon am Ärmelende
- Farben: orange/gelb, grau/weiss

Größe: XXS-5XL

orange/gelb **BC26004**

grau/weiss **BC26005**



## SHORT SLEEVES JERSEY GENT

- Airbreath polyester
- Mesh inserts on both sides
- Siliconed elastics on the sleeve openings
- Colors: orange/yellow, gray/white

Sizes: XXS-5XL

orange/yellow **BC26000**

gray/white **BC26001**

## BIBSHORT GENT

- Lycra Sport Compression fabric
- Flat seams

• Colors: orange/yellow, gray/white

Sizes: XXS-5XL

orange/yellow **BC26004**

gray/white **BC26005**

## CASUAL



### T-SHIRT CORRATEC

Größen: XS-3XL

LW23003

### PREMIUM LION POLOSHIRT GENT

Größen: XS-4XL

LW26000

### LIONS JACKE MIT KAPUZE

- 45% Polypropylene, 44% Wolle, 11% Polyamid; Thermofleece

- Ultra leichtes Material, atmungsaktiv

Größen: XS-4XL

LW21002

### CORRATEC PREMIUM JEANS

- 99% Cotton, 1% Elastane

Größen: 26, 28, 30, 32, 34, 36, 38, 40

BC27013



### T-SHIRT CORRATEC

Sizes: XS-3XL

LW23003

### PREMIUM LION POLOSHIRT GENT

sizes: XS-4XL

LW26000

### LIONS LEASURE JACKET WITH HOOD

- 45% Polypropylène, 44% Laine, 11% Polyamide, Thermofleece

- ultra light fabric, antibacterial, breathable

Sizes: XS-4XL

LW21002

### CORRATEC PREMIUM JEANS

- 99% Cotton, 1% Elastane

Sizes: 26, 28, 30, 32, 34, 36, 38, 40

BC27013

## SPORTS BAG



Design trifft auf Strapazierfähigkeit: Unsere unglaublich robuste corratec Team Tasche ist ein ultimativer Begleiter auf all Deinen Rennausflügen. Die Sporttasche bietet Dir extra viel Platz, damit bei Deinem nächsten Ausflug alles dabei ist, was Du am Berg oder während des Rennens brauchst. Dank dem ergonomischen Schultergurt und den gepolsterten Traggriffen kannst Du die Tasche ganz einfach überallhin mitnehmen. Im Inneren geben Dir Mesh-Taschen die Möglichkeit, all Deine Habseligkeiten sicher und gut organisiert zu verstauen.

### CORRATEC SPORTS BAG

- 1000D phthalate-free TPE fabric laminate, 840D Jr. ballistic nylon
- Farben: Blau / Schwarz
- erhältlich in 2 Größen:  
klein: 30cm x 60cm x 30cm (50 Liter)  
mittel: 35 x 65 x 35cm (70 Liter)

BC24008



Corratec design and legendary durability: The super-tough corratec Race Bag is the ultimate expedition bag. This bag has all the room you need so that nothing gets left behind on your next adventure. An ergonomic shoulder strap and padded side handles make it easy to carry when you're on the move. Inside, mesh pockets keep everything organized and secure.

### CORRATEC SPORTS BAG

- 1000D phthalate-free TPE fabric laminate, 840D Jr. ballistic nylon
- Color: blue / black
- available in 2 sizes:  
small: 30cm x 60cm x 30cm (50 liter)  
medium: 35 x 65 x 35cm (70 liter)

BC24008





# RAHMENSETS FRAMESETS

Die Rahmentechnologien aus dem Hause corratec sind einzigartig in der Branche. Deshalb ist es auch möglich, Rahmen einzeln zu bekommen. Somit musst Du nicht auf die High-Performance Rahmen verzichten, wenn Du Dir Dein Traumbike selbst zusammenstellst.

The frame technologies from corratec are unique in the bicycle industry. For this reason we provide the possibility to order particular corratec frame kits. Therefore you have the opportunity to build your own unique dream bike based on a high quality corratec frame.





# RAHMENSETS FRAMESETS



## CCT EVO SL DISC

- ✓ CCT EVO kompatibel mit Di2
- || Pro Control Voll Carbon Gabel
- Integriertes konisches und abgedichtetes Lager, Carbon-Gabelschaft-Einsatz.

- Kompatible Innenlager, bei Bedarf separat bestellen.  
Shimano Road Duble UBBS  
Shimano Road Triple UBBS  
Campagnolo UBBS  
BB30 (Direkter Einbau in den Rahmen.)

## CCT EVO SL DISC

- ✓ CCT EVO specifically for Di2 gears.
- || Pro Control Full carbon fork
- Headset, Integrated tapered, sealed bearing, carbon steerer insert

- Compatible bottom brackets, order separately if required.  
Shimano Road Duble UBBS  
Shimano Road Triple UBBS  
Campagnolo UBBS  
BB30 (Direct fit into frame.)

† 46 | 48 | 51 | 54 | 57 | 60



## CCT TEAM DISC

- ✓ CCT Team kompatibel mit Di2
- || Pro Control Voll Carbon Gabel
- Integriertes konisches und abgedichtetes Lager, Carbon-Gabelschaft-Einsatz.

- Kompatible Innenlager, bei Bedarf separat bestellen.  
Shimano Road Duble UBBS  
Shimano Road Triple UBBS  
Campagnolo UBBS  
BB30 (Direkter Einbau in den Rahmen.)

## CCT TEAM DISC

- ✓ CCT Team specifically for Di2 gears.
- || Pro Control Full carbon fork.
- Headset, Integrated tapered, sealed bearing, carbon steerer insert.

- Compatible bottom brackets.
- Shimano Road Duble UBBS  
Shimano Road Triple UBBS  
Campagnolo UBBS  
BB30 (Direct fit into frame.)

† 46 | 48 | 51 | 54 | 57 | 60



## C:TIME

- ✓ Voll Carbon Zeitfahr- und Triathlon Rahmen.  
Inklusive Carbon Zeitfahrenlenker.
- || Carbon Aero Gabel.
- Steuersatz, 1 1/8.  
Carbon Aero Sattelstütze und Sattelklemme.

- Kompatible Innenlager:  
BSA Gewinde.

## C:TIME

- ✓ Full carbon Time Trail and triathlon chassis.  
Incl. Carbon Time Trial Handlebar.
- || Carbon Aero fork.
- Headset, 1 1/8  
Carbon Aero seat post  
Seatclamp
- compatible bottom brackets  
BSA Threaded

† 46 | 48 | 51 | 54 | 57 | 60



**POWERHOUSE**

Extrem breites Tretlager für maximale Kraftübertragung und Stabilität.

Dies macht corrateg Carbon Rahmen zu der ersten Wahl bei harten Rennen.

**POWERHOUSE**

Oversized BB construction – for maximum power transmission and stability.

The first choice for hard races.

**EPS CARBON GEFERTIGT**

corrateg Carbon Rahmen werden nach dieser Fertigungsmethode produziert.

Das EPS Verfahren gewährleistet die außerordentliche Steifigkeit, Leichtbau sowie das herausragende Design.

**EPS CARBON MADE**

corrateg Carbon Frames are producing according to this method.

The EPS procedure ensure outstanding stiffness, lightweight as well as elegant design.

**SPEZIELLE RAHMENFORMEN**

corrateg nutzt spezielle Rahmenkonstruktionen wie das quadratische Oberrohr des Revolution iLink.

Das Resultat: Steifigkeit und Leichtbau in einem Paket.

**UNIQUE FRAME GEOMETRIES**

corrateg uses unique frame constructions as the square head tube of the Revolution iLink.

The result: Stiffness and lightweight in one package.



**REVO BOW**

- ✓ XC Race und marathon Hardtail.
- || Integriertes konisches und abgedichtetes Lager. Vollintegrierter Steuersatz von Acros.
- Kompatible Innenlager, bei Bedarf separat bestellen.
- Kompatible Innenlager, bei Bedarf separat bestellen.  
Shimano MTB UBBS  
GXP MTB UBBS  
BB30 (Direkter Einbau in den Rahmen.)

**REVO BOW**

- ✓ XC Race und marathon hardtail.
- || Integrated tapered, sealed bearing.
- Compatible bottom brackets, order separately if required.
- Compatible bottom brackets, order separately if required.  
Shimano MTB UBBS  
GXP MTB UBBS  
BB30 (Direct fit into frame.)

# 39 | 44 | 49 | 54



**REVOLUTION iLINK**

- ✓ XC Race and marathon full suspension  
Headset, Integrated tapered, sealed bearing  
Syntace x-12 Axle  
Syntace x-12 gear hanger
- Integriertes konisches und abgedichtetes Lager.
- Kompatible Innenlager, bei Bedarf separat bestellen.

**REVOLUTION iLINK**

- ✓ XC Race and marathon full suspension.  
Headset, Integrated tapered, sealed bearing.  
Syntace x-12 Axle  
Syntace x-12 gear hanger
- Integriertes konisches und abgedichtetes Lager.
- Kompatible Innenlager, bei Bedarf separat bestellen.

# 44 | 48 | 52

# KONTAKT CONTACT

## ADRESSE

iko Sportartikel Handels GmbH  
Kufsteiner Str. 72  
D-83064 Raubling / Germany  
Tel: +49 (0) 8035 8707 0  
Fax: +49 (0) 8035 8707 240  
E-Mail: info@corrateg.com

[www.corrateg.com](http://www.corrateg.com)

**B2B Shop:**  
[b2b.corrateg.com](http://b2b.corrateg.com)

Eigentümer &  
Geschäftsführung

**Konrad und Cielo Irlbacher**

**Nachfolge geregelt:  
(von links nach rechts)**

**Konrad Jun. Irlbacher**

**Tessa Irlbacher**

**Johannes Irlbacher**



## MITGLIED DER GESCHÄFTSLEITUNG, HEAD OF SALES, MARKETING & SERVICE

**Günther Schoberth-Schwingenstein**  
E-Mail: [guenther.schoberth-schwingenstein@corrateg.com](mailto:guenther.schoberth-schwingenstein@corrateg.com)

## DEBITOREN & RISK MANAGEMENT

**Sabine Enghart**  
E-Mail: [enghart@corrateg.com](mailto:enghart@corrateg.com)  
Tel: +49 (0) 8035 8707 131  
Fax: +49 (0) 8035 8707 240

## TEAMLEITUNG VERTRIEBSINNENDIENST

**Bettina Ebner**  
E-Mail: [bettina.ebner@corrateg.com](mailto:bettina.ebner@corrateg.com)  
Tel: +49 (0) 8035 8707 122  
Fax: +49 (0) 8035 8707 240

## MARKETING

**Veronica Metz**  
E-Mail: [veronica.metz@corrateg.com](mailto:veronica.metz@corrateg.com)  
[marketing@corrateg.com](mailto:marketing@corrateg.com)  
Tel: +49 (0) 8035 8707 198  
Fax: +49 (0) 8035 8707 240

**Andreas Schmoranzer**  
E-Mail: [andreas.schmoranzer@corrateg.com](mailto:andreas.schmoranzer@corrateg.com)  
[marketing@corrateg.com](mailto:marketing@corrateg.com)  
Tel: +49 (0) 8035 8707 192  
Fax: +49 (0) 8035 8707 240

**Alexander Prokein**  
E-Mail: [alexander.prokein@corrateg.com](mailto:alexander.prokein@corrateg.com)  
[marketing@corrateg.com](mailto:marketing@corrateg.com)  
Tel: +49 (0) 8035 8707 117  
Fax: +49 (0) 8035 8707 240

**Frank Brunotte**  
E-Mail: [frank.brunotte@corrateg.com](mailto:frank.brunotte@corrateg.com)  
[marketing@corrateg.com](mailto:marketing@corrateg.com)  
Tel: +49 (0) 8035 8707 197  
Fax: +49 (0) 8035 8707 240



## TEAMLEITUNG SERVICE

### Lars Furch

E-Mail: [service@corrateg.com](mailto:service@corrateg.com)  
Tel: +49 (0) 8035 8707 180  
Fax: +49 (0) 8035 8707 240

## SERVICE

### Werner Scheidig

E-Mail: [service@corrateg.com](mailto:service@corrateg.com)  
Tel: +49 (0) 8035 8707 180  
Fax: +49 (0) 8035 8707 240

Erreichbarkeit:  
Mo-Fr. 8-12 Uhr

## VERTRIEBSTEAM

### Holger Pastoors

Sales Manager West | Mitte | Nord  
20-29 | 32 | 33 | 40-49 | 50-59 | 61-65 | 67  
E-Mail: [holger.pastoors@corrateg.com](mailto:holger.pastoors@corrateg.com)  
Tel: +49 (0) 172 99 17 097

### Frank Fiedler

Sales Manager Mitte  
01-19 | 30 | 31 | 34-39 | 95 | 96 | 98 | 99  
E-Mail: [fiedler@corrateg.com](mailto:fiedler@corrateg.com)  
Tel: +49 (0) 172 99 17 101

### Holger von Homeyer

Sales Manager BAWÜ  
70-79 | 88 | 89 | 66 | 68 | 69  
E-Mail: [holger.von.homeyer@corrateg.com](mailto:holger.von.homeyer@corrateg.com)  
Tel: +49 (0) 172 99 17 094

### Rainer Trost

Regionalleitung Süd  
80-87 | 90-94 | 97  
E-Mail: [trost@corrateg.com](mailto:trost@corrateg.com)  
Tel: +49 (0) 172 99 17 099

### Mario Gwiggner

Sales Manager Österreich & Südtirol  
E-Mail: [mario.gwiggner@corrateg.com](mailto:mario.gwiggner@corrateg.com)  
Tel: +43 (0) 664 24 14 469

### Angélique Sainz

Sales Manager Schweiz  
E-Mail: [angelique.sainz@corrateg.com](mailto:angelique.sainz@corrateg.com)  
Tel: +41 (0) 794 26 67 19

# CORRATEC GLOBAL

## LEITUNG EXPORT

Cielo Irlbacher

E-Mail:

irlbacher-g@corrateg.com

## PRIVATE LABEL

Maximilian Lex

E-Mail: lex@corrateg.com

Tel: +49 (0) 8035 8707 190

Fax: +49 (0) 8035 8707 240

## EXPORT

Korbinian Weiß

Export International Sales

E-Mail: korbinian.weiss@corrateg.com

Tel: +49 (0) 8035 8707 128

Fax: +49 (0) 8035 8707 240

Simon Walz

Export International Sales

E-Mail: simon.walz@corrateg.com

Tel: +49 (0) 8035 8707 118

Fax: +49 (0) 8035 8707 240

# *corrateg*

## PARTNER USA I AMERICA

## USA I AMERICA SUBSIDIARY

Fernando Bolona

E-Mail: fernando.bolona-icf@corrateg.com

Tel: +1 (0) 954 536 9910

## NEW YORK I NEW JERSEY

PHILADELPHIA

FELIXBIKE LLC

info@felixbike.com

## FLORIDA I MASSACHUSETTS

TEXAS

CORRATEC FLORIDA INC.

fernando.bolona-icf@corrateg.com

# AUTHORIZED

# *corrateg*

## PARTNER WORLDWIDE

## BENELUX

WIKI SPORTS BVBA

info@wikisports.be

## BOSNIA & HERZEGOVINA

WOLF BIKES D.O.O.

prodaja@wolfbikes.info

## BRAZIL

RELM TECNOLOGIA LTDA

relm@relm.com.br

## CHILE

IMPORTADORA ALEJANDRO LILLO

alejandrolillo@gmail.com

## COLUMBIA

FIECRISE SAS

compras@cyclingpro.co

## CROATIA

MIHALEC TRGOVINA D.O.O.

info.beciklin@gmail.com

## CZECH REPUBLIC

CORRATEC SALES AGENT  
LUBOMIR SZABADZALLASI

lubomir@corrateg.com

## DOMENICAN REPUBLIC

ASESORIA Y SERVICIOS BD, S.R.L.

williamguzman08@gmail.com

## ECUADOR

TOPBIKE

rossana@topbikeecuador.com

## FINLAND

BIKEIMPORT FINLAND OY

jari@bikeimport.fi

## FRANCE

CORRATEC SALES AGENT  
JIMMY REMY

jimmy@sportsandmore-france.com

## GUATEMALA I NICARAGUA I HONDURAS I EL SALVADOR

DISTRIBUIDORA CENTROAMERICANA  
DE BIENES Y SERVICIOS S.A.

rmendez@garmincentroamerica.com





### **GREECE**

KASSIMATIS N. G. SOLE SHAREHOLDER  
CO. LTD.

info@kassimatiscycling.gr

### **HUNGARY**

CORRATEC SALES AGENT  
LUBOMIR SZABADSZALLASI

lubomir@corrateg.com

### **ICELAND**

HJÓLASPETTUR EHF

hjolassprettur@hjolassprettur.is

### **IRELAND**

PRIMA SPORT LTD.

info@primasport.ie

### **ITALY**

BOSS EQUIPMENT SRL

info@bossequip.com

### **LITHUANIA I ESTONIA I LATVIA**

IMENZA UAB

info@imenza.lt

### **MALTA**

THE CYCLIST

info@thecyclistmalta.com

### **MEXICO**

BIKE CHECK STUDIO

rodrigo@bikecheckstudio.com

### **NEW ZEALAND**

SWITCHED ON BIKES LTD

ryan@switchedonbikes.co.nz

### **NORWAY**

XXL GROSIT NORYE AS

### **PANAMA I VENEZUELA**

WC INTERNACIONAL GROUP CORP.

kundeservice@xxl.no

### **POLAND**

POLBIKE JULIUSZ KABATH

polbike@rubikon.pl

### **SLOVAKIA**

CORRATEC SALES AGENT  
LUBOMIR SZABADSZALLASI

lubomir@corrateg.com

### **SLOVENIA**

A2U D.O.O

eshop@a2u.si

### **SWEDEN**

TCM ONLINE RETAIL

info@tcmykel.se

### **SPAIN I PORTUGAL**

VIC SPORTS AFERS S.L.

info@vicsportsafers.es

### **PUERTO RICO**

EMANUEL IBARRY AND 2ND BIKE LLC

eibarryand2ndbike@gmail.com

### **TURKEY**

DELTA BISIKLET MOTOSIKLET

info@deltabisiklet.com

### **UNITED KINGDOM**

EBCO LTD.

info@ebco.co.uk

### **VENEZUELA**

MANUANDRI

endurocrosscenter@hotmail.com





**Publisher:**

iko Sportartikel Handels GmbH  
Kufsteiner Str 72  
D-83064 Raubling  
www.corrattec.com

**Irrtümer und Änderungen vorbehalten.  
Bei den UVPs handelt es sich um unverbindliche  
Preisempfehlungen in Euro.**

Stand: September 2022  
Version 2022 2.0  
Auflage: 1800 Stk.

Die in diesem Katalog abgebildeten Bikes sind zum Teil mit aufpreispflichtigen Ausstattungsoptionen gebaut. Alle MTB- und Rennradpedalsysteme sind Sonderausstattungen.

Die angegebenen Fahrradgewichte sind circa Angaben und können auf Grund von Produktionstoleranzen geringfügig variieren.

Bilder nur zur Illustration der Farben.  
Für genauere Informationen die Spezifikationsliste beachten. Geringfügige Farbabweichungen sind produktionsbedingt möglich.

Es darf keine Kommunikation über die von Bosch betroffenen Produkte an Dritte erfolgen.

Changes reserved according to our general terms and conditions.  
Prices are non-binding recommended retail prices (RPP) stated in Euro.

As of September 2022  
Version 2022 2.0  
Print run: 1800 pcs.

The bikes shown in this catalogue are partly configured with upcharge options. All MTB and race pedal systems are optional.

Due to tolerances in the production, the weights of the bikes can differ slightly and are therefore quoted as approximate weights.

Image for colour illustration only.  
See written specification. Due to production tolerances, slight color deviations may occur.

No communication may be made to third parties about the products affected by Bosch.